



Industrial Computer Products

Data Acquisition Systems

ET-7x00/PET-7x00 Series

User Manual



ET-7000/ET-7200 Series
(Ethernet I/O)



PET-7000/PET-7200 Series
(PoE I/O)

Author: Liam Lin
Editor: Janice Hong

Version 1.1.5, 01. 2026

Warranty

All products manufactured by ICP DAS are under warranty regarding defective materials for one year, beginning from the date of delivery to the original purchaser.

Warning

ICP DAS assumes no liability for any damage resulting from the use of this product.
ICP DAS reserves the right to change this manual at any time without notice.

The information furnished by ICP DAS is believed to be accurate and reliable. However, no responsibility is assumed by ICP DAS for its use, nor any infringements of patents or other rights of third parties resulting from its use.

Copyright

Copyright © 2014 by ICP DAS CO., LTD. All rights are reserved.

Trademarks

The names are used for identification purposes only and may be registered trademarks of their respective companies.

Contact Us

If you have any problems, please feel free to contact us. You can count on us for a quick response.

Email: service@icpdas.com

Revision History

The table below shows the revision history.

Revision	Date	Description
1.1.5	Jan. 2026	<ul style="list-style-type: none"> ● Revise Appendix D Modbus Data Scaling and Unit Conversion
	Aug. 2025	<ul style="list-style-type: none"> ● Modify Section 1.3 Dimensions
	May. 2025	<ul style="list-style-type: none"> ● Modify Section 3.2.3 (D) DI Low-Pass Filter ● Add Section 6.4.2 Update a firmware by using eSearch
1.1.4	May. 2024	<ul style="list-style-type: none"> ● Since FW3.11 (or later), the factory defaults for ID or password are not supported. Users need to create them during their initial login. Refer to Section 3.3 for the updated information on Authentication. ● Since FW3.11 (or later), a maintenance feature has been added that enables users to export/import configurations, making bulk module configuration easier. Refer to Section 3.6 for an explanation of Maintenance.
1.1.3	Jun. 2023	<ul style="list-style-type: none"> ● Add Section 3.2.3-(F) NTC Thermistor Temperature Settings - User Defined Type
	Oct. 2022	<ul style="list-style-type: none"> ● Add chapters <ul style="list-style-type: none"> 3.4.1 Add pictures for AO, DI, DO 6.3.2 Using the 7188EU.exe and Command Line Appendix E Convert Modbus Data to the Actual Value ● Remove chapters <ul style="list-style-type: none"> 1.4. Companion CD 2.6. Enabling the Adobe Flash Player in Your Browser 4.3. Data Encoding 4.4. Data Model Appendix A. Node Information Area Appendix B. Thermocouple ● Change the Title <ul style="list-style-type: none"> 4.1 Modbus TCP/IP Message Format 4.2. Function Code
1.1.2	Feb. 2014	<ul style="list-style-type: none"> ● Added product information for the ET-7200/PET-7200 in each section of the manual.
1.1.1	Apr. 2013	<ul style="list-style-type: none"> ● Added the tip about selecting the input/output range of each analog input/output channel in section 3.2.3. (D) Analog Output Settings and 3.2.3. (E) Analog Input Settings.

Revision	Date	Description
1.1.0	Feb. 2013	● Added the I/O configuration instructions in section 2.7. Configuring the I/O Functions.
1.0.1	Dec. 2011	● Initial issue

Table of Contents

Chapter 1. Introduction	8
1.1. Features.....	10
1.2. Overview.....	13
1.3. Dimensions.....	16
Chapter 2. Getting Started	19
2.1. Mounting the ET-7x00/PET-7x00.....	20
2.2. Configuring the Boot Mode.....	21
2.3. ET-7x00/PET-7x00 Hardware Connections	22
2.4. Installing the MiniOS7 Utility	24
2.5. Using the MiniOS7 Utility to Assign an IP Address.....	25
2.6. Configuring the I/O Functions.....	28
Chapter 3. Web Applications.....	32
3.1. Overview.....	34
3.2. Configuration.....	35
3.2.1. Network Settings	36
3.2.2. Basic Settings	37
3.2.3. Module I/O Settings.....	46
3.3. Authentication.....	62
3.3.1. Account Management	63
3.3.2. Accessible IP Settings.....	66
3.4. Web HMI.....	67
3.4.1. Web HMI	68
3.4.2. Web Edit	70
3.5. I/O Pair Connection	79
3.5.1. Example 1: Pair Connection - AI to AO	82

3.5.2. Example 2: Pair Connection - DI to DO	87
3.6. Maintenance	91
3.7. More Information.....	95
Chapter 4. Modbus TCP/IP.....	96
4.1. Modbus TCP/IP Message Format	96
4.2. Function Code	99
4.2.1. 01 (0x01) Read Coils	99
4.2.2. 02 (0x02) Read Discrete Inputs.....	100
4.2.3. 03 (0x03) Read Holding Registers	101
4.2.4. 04 (0x04) Read Inputs Registers	102
4.2.5. 05 (0x05) Write Single Coil	103
4.2.6. 06 (0x06) Write Single Register	104
4.2.7. 15 (0x0F) Write Multiple Coils.....	105
4.2.8. 16 (0x10) Write Multiple Registers.....	106
4.3. Modbus Master Simulators.....	107
4.3.1. Modbus/TCP Client.....	107
4.3.2. Modbus Master Tool.....	110
4.4. Modbus Demo Programs	113
Chapter 5. Calibration.....	114
5.1. Voltage and Current Calibration.....	114
5.2. Thermocouple Calibration.....	119
5.3. RTD Calibration.....	120
5.4. Recover Calibration to the Factory Setting	122
Chapter 6. MiniOS7 Utility Tools	123
6.1. Establishing a Connection	123
6.2. Exchanging the Protocol (TCP/IP to UDP).....	126
6.3. Updating the OS	127

6.3.1. Using the MiniOS7 Utility	127
6.3.2. Using the 7188EU.exe and Command Line	131
6.4. Updating the Firmware	133
6.4.1. Using the MiniOS7 Utility	133
6.4.2. Using the eSearch Utility	136
Chapter 7. SCADA and System Integration Tools	138
7.1. LabVIEW	138
7.2. OPC Server.....	139
7.3. SCADA.....	140
7.3.1. InduSoft	141
7.3.2. Citect.....	142
7.3.3. iFix.....	143
Appendix A Description of I/O Functions	144
A.1. Dual Watchdog	144
A.2. Power-on Value.....	145
A.3. Safe Value	147
A.4. AI High/Low Alarm.....	149
A.5. AI High/Low Latch.....	154
Appendix B Analog Input Type and Data Format Table	155
Appendix C Analog Output Type and Data Format Table.....	160
Appendix D Modbus Data Scaling and Unit Conversion.....	161
Appendix E Network Address Translation.....	166
Appendix F Troubleshooting	168

Chapter 1. Introduction

The ET-7200/PET-7200 series is a kind of Ethernet I/O module, including Analog Input/Output, Digital Input/Output, Power Relay, Thermocouple, and RTD modules. The ET-7200/PET-7200 series provides full networking capabilities, and a variety of I/O functions, together with web-based Ethernet I/O monitoring and control modules, meaning that the modules can be remotely controlled using the Modbus TCP/UDP protocol via a 10/100 M Ethernet network.

Modbus has become the de facto standard protocol for industrial communication and is now the most commonly available means of connecting industrial electronic devices. This ensures that the ET-7200/PET-7200 series provides perfect integration with HMI, SCADA, PLC, and other industrial control software systems.



Visit the ET-7000/ET-7200 selection guide page to choose the desired modules.

Analog I/O Modules:

https://www.icpdas.com/en/product/guide+Remote_I_O_Module_and_Unit+Ethernet_I_O_Modules+ET-7000#650

Digital I/O Modules:

https://www.icpdas.com/en/product/guide+Remote_I_O_Module_and_Unit+Ethernet_I_O_Modules+ET-7000#652

Encoder/Frequency/Counter:

https://www.icpdas.com/en/product/guide+Remote_I_O_Module_and_Unit+Ethernet_I_O_Modules+ET-7000#654

Comparison between (P)ET-7000 and (P)ET-7200 Series

The PET-7x00 has some unique features that are different from the ET-7x00

Model	ET-7000	PET-7000	ET-7200	PET-7200
Software				
Embedded Web Server	Yes			
Web HMI	Yes			
I/O Pair Connection	Yes			
CPU Module				
Dual Watchdog	Module, Communication (Programmable)			
Ethernet				
Ports	1 x RJ-45, 10/100M Base-TX		2 x RJ-45, 10/100 Base-TX, Switch Ports	
Security	ID, Password, and IP Filter			
Protocol	Modbus TCP and Modbus UDP			
LED Indicators				
System Operation	Yes			
Ethernet Link/Activity	Yes			
I/O Status	-		Yes	
Power				
Reverse Polarity Protection	Yes			
Powered from PoE	-	Yes	-	Yes
Powered from Terminal Block	+10 ~ +30 VDC	+12 ~ +48 VDC	+12 ~ +48 VDC	
Power Inputs	One pair		Two pairs	
Mechanical				
Dimensions (mm)	72 x 123 x 35 (W x L x H)		Plastic Casing: 76 x 120 x 42 (W x L x H) Metal Casing: 97 x 130 x 38 (W x L x H)	
Other				
Reset Button	-		Yes	

1.1. Features

Power over Ethernet (PoE)

The **PET-7x00** series module features true IEEE802.3af-compliant (classification, Class 1) PoE technology that allows both power and data to be carried over a single Ethernet cable, meaning that a device can operate solely from the power it receives through the data cable. This also eliminates the need for additional wiring and power supply.



Daisy-Chain Ethernet Cabling

The **ET-7200/PET-7200** series has a built-in two-port Ethernet switch to implement daisy-chain topology. The cabling is much easier and the total costs of cable and switch are significantly reduced.



LAN Bypass



The **ET-7200/PET-7200** series modules provide a LAN bypass feature that guarantees Ethernet communication. It will automatically activate to continue the network traffic when the module loses its power.

Communication Security

To change the settings or monitor the status of I/O, the account and password are needed when logging into the web server. An IP address filter is also included, which can be used to allow or deny connections with specific IP addresses.

Support for both Modbus TCP and Modbus UDP Protocols

The Modbus TCP/UDP slave function Ethernet port can be used to provide data to remote SCADA software.

Built-in I/O

Various I/O components are mixed with multiple channels in a single I/O module, which provides the most cost-effective I/O usage and enhances the performance of I/O operations.

Dual Watchdog

The Dual Watchdog consists of a Module Watchdog and a Communication Watchdog. The action of AO and DO is also associated with the Dual Watchdog.

Module Watchdog is a built-in hardware circuit to monitor the operation of the module and will reset the CPU if a failure occurs in the hardware or the software. Then the Power-on Value of AO and DO will be loaded.

Communication Watchdog is a software function to monitor the communication between the host and the I/O module. The timeout of the communication Watchdog is programmable, when the I/O doesn't receive commands from the host for a while, the watchdog forces the AO and DO to pre-programmed the Safe Value to prevent unpredictable damage to the connected devices.

Highly Reliable Under Harsh Environment

Wide Operating Temperature Range: -25 ~ +75°C

Storage Temperature: -30 ~ +80°C

Humidity 10 ~ 90% RH (Non-condensing)



I/O Pair Connection

This function is used to create an AI/DI to AO/DO pair through the Ethernet. Once the configuration is completed, the I/O module can poll the status of remote AI/DI devices and then use the Modbus TCP protocol to continuously write to local AO/DO channels in the background.

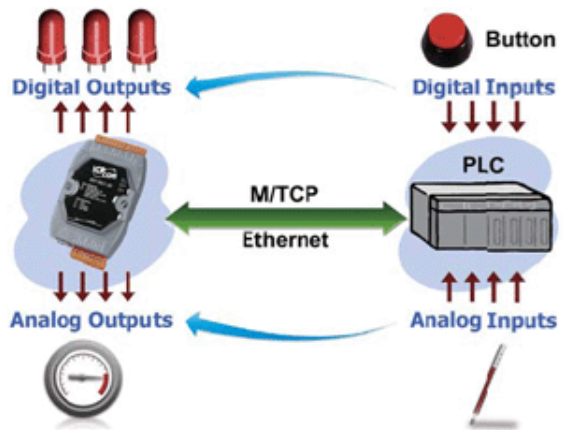

Power-on Value and Safe Value

Besides setting by the set AO and DO commands, the AO and DO can be set under two other conditions.

Power-on Value: The Power-on Value will be loaded to the AO or DO on three conditions: Power-on, reset by Module Watchdog and reset by reset command.

Safe Value: When the Communication Watchdog is enabled and a Communication Watchdog timeout occurs, the "safe value" is loaded into the AO, DO.

LED indicators for DIO status

The LED indicators for DIO status are for the ET-7200/PET-7200 series.

Reset button

The reset button is for the ET-7200/PET-7200 series. It is used to clear all data and restore all settings to factory default values. It is very useful especially when you forget the ID, password to log into the web server, or IP address to access the Ethernet I/O module.

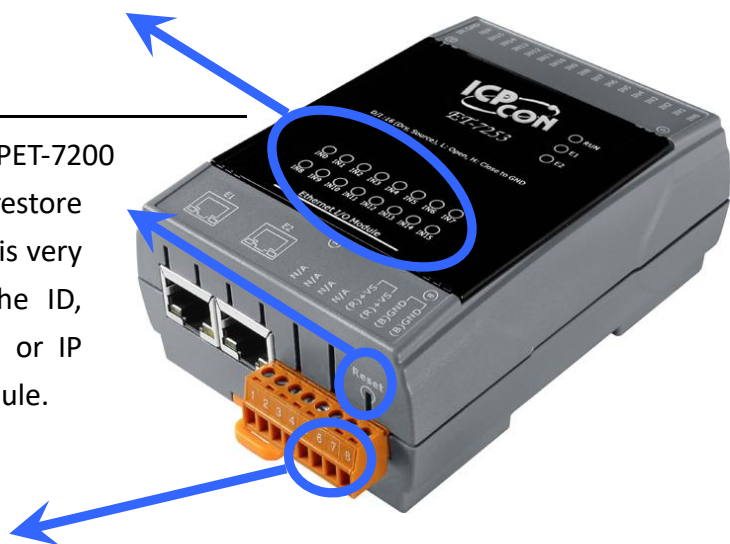

Two pairs of power input pins

For (P)ET-7000 series, there are only two pins for power input. To ease the wiring, the pins are increased to four pins as two pairs for (P)ET-7200 series.

1.2. Overview

The front panel of the ET-7x00/PET-7x00 series module contains the Ethernet Port, connectors, and LEDs. Refer to data sheets for specific ET-7x00/PET-7x00 models for details of pin assignments, which can be found at:

https://www.icpdas.com/en/product/guide+Remote_I_O_Module_and_Unit+Ethernet_I_O_Modules+ET-7000

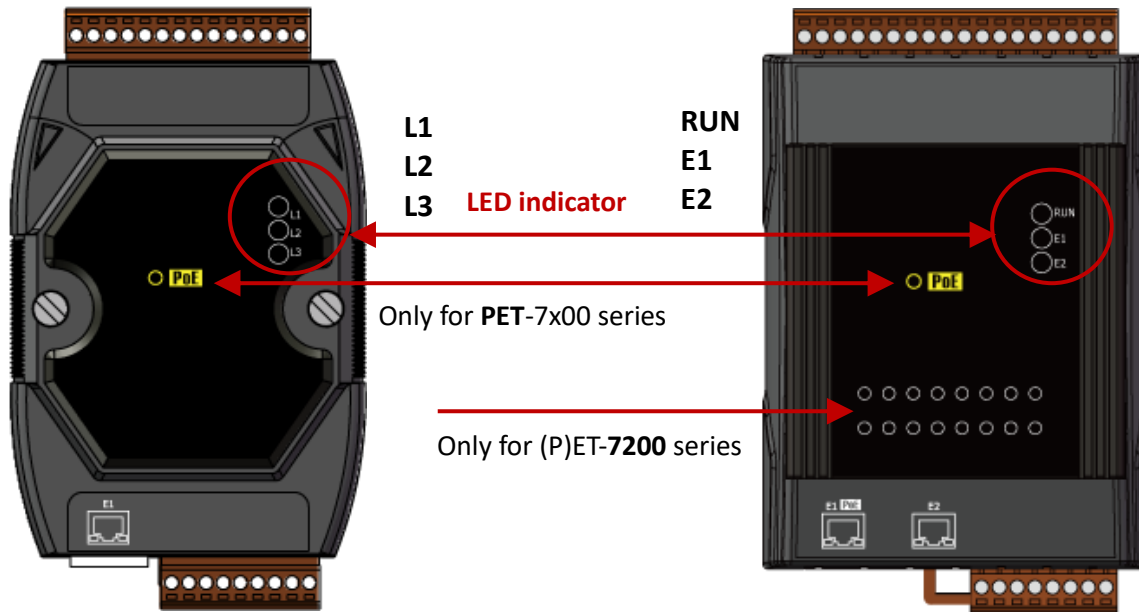

Model	Label	Status	Description
ET-7000/ PET-7000	L1	Flashing	The unit is turned on and is ready for use.
	L2	On	A link has been established on the E1 port.
		Off	No link is established on the E1 port.
		Flashing	Data transmission or receiving activity is occurring on the E1 port.
	L3	On	The E1 port is operating at 100 Mb/s.
		Off	The E1 port is operating at 10 Mb/s.
ET-7200/ PET-7200	RUN	Flashing	The unit is turned on and is ready for use.
	E1	On	A link has been established on the E1 port.
		Off	No link is established on the E1 port.
		Flashing	Data transmission or receiving activity is occurring on the E1 port.
	E2	On	A link has been established on the E2 port.
		Off	No link is established on the E2 port.
		Flashing	Data transmission or receiving activity is occurring on the E2 port.

The bottom panel of the ET-7x00/PET-7x00 module contains the Ethernet port and the reset button. Note that the PoE function is only for PET-7000 and PET-7200.

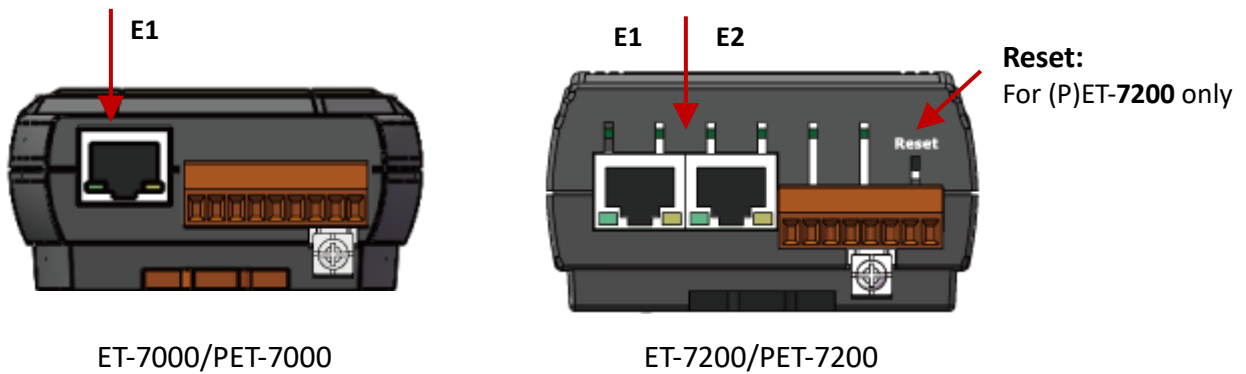

Reset button (for ET-7200/PET-7200 series modules only)

The reset button is used to restore the following settings to their factory defaults by pressing and holding the reset button for 5 seconds.

- Network Settings
- Authentication
- Web HMI
- Pair Connection

For more information about these settings, refer to section 3.2.2. "Basic Settings - (C)".

The back panel of the ET-7x00/PET-7x00 series module contains the frame ground and the operating mode selector switch.

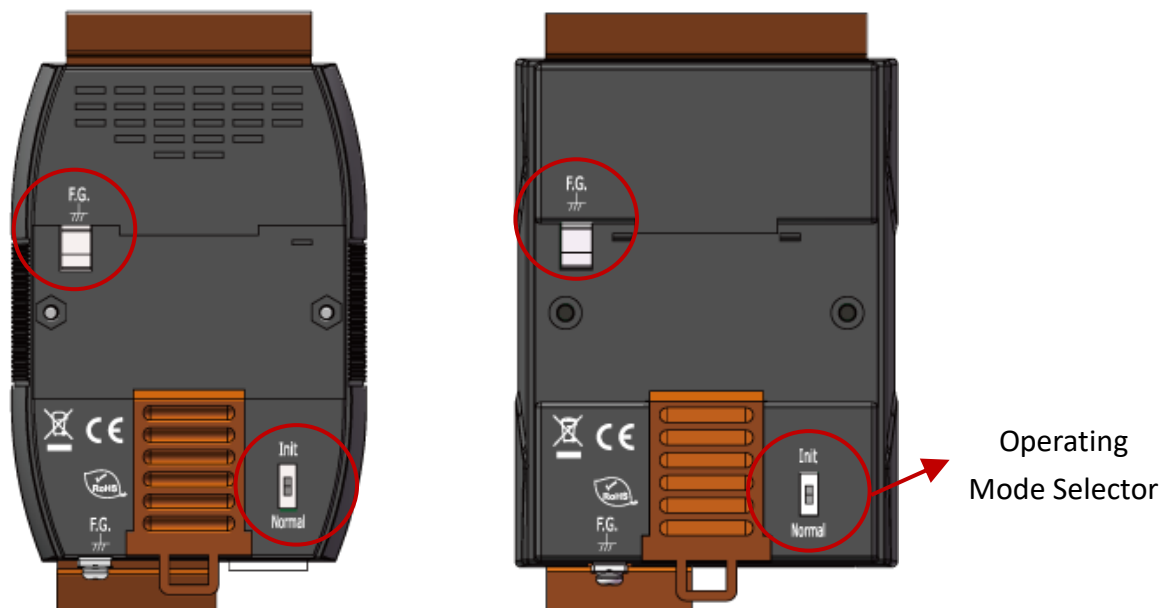

Operating Mode Selector Switch

Init Mode:

This mode is used for MiniOS7 configuration.

Normal Mode:

This mode is used to execute and run firmware.

On the ET-7x00/PET-7x00 series module, the operating mode selector switch should usually be in the Normal position. The switch should only be moved from the **Normal** position to the **Init** position when updating the ET-7x00/PET-7x00 firmware or the OS. Once the update has been completed, ensure that the switch is returned to the Normal position.

Frame Ground

Electronic circuits are constantly vulnerable to Electrostatic Discharge (ESD), which becomes worse in a continental climate area. The ET-7x00/PET-7x00 series features a new design for the frame ground that provides a path for bypassing ESD, allowing enhanced static (ESD) protection capabilities and ensuring that the module is more reliable.

As the figure below, the user can choose one of the frame grounds to provide a better level of protection for the module. These two frame grounds are conductive inside the module. When a DIN-Rail is mounted, it will in contact with the metallic board of the upper F.G., so a ground wire can be connected to either the lower F.G. or to the DIN-Rail.

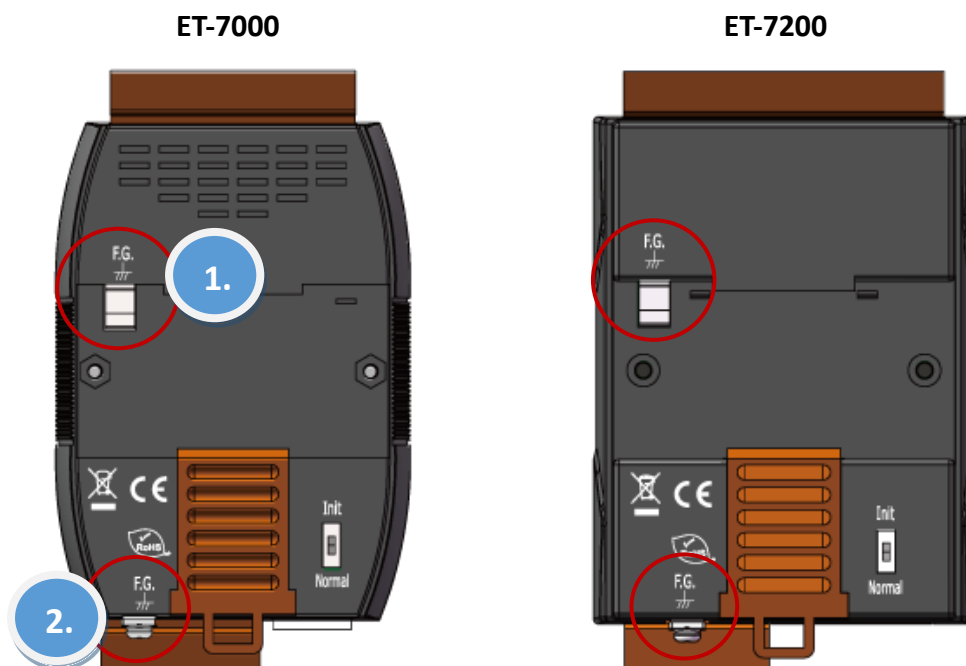

1.3. Dimensions

The following diagrams provide the dimensions of the ET-7x00/PET-7x00 module and can be used as a reference when defining the specifications for any custom enclosures. All dimensions are in millimeters.

For the (P)ET-7000 Series: 72 x 123 x 35

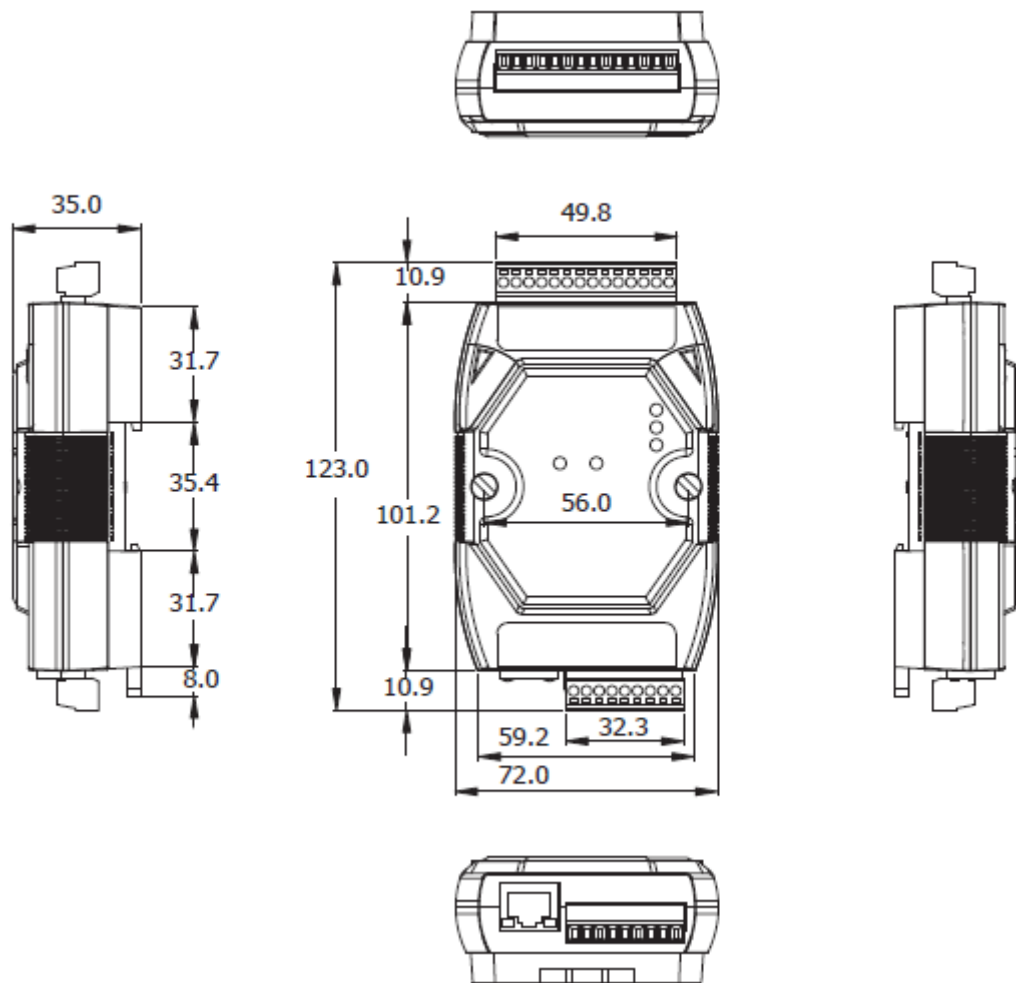

For the (P)ET-7200 Series:

Plastic Casing: 76 x 120 x 42 (W x L x H)

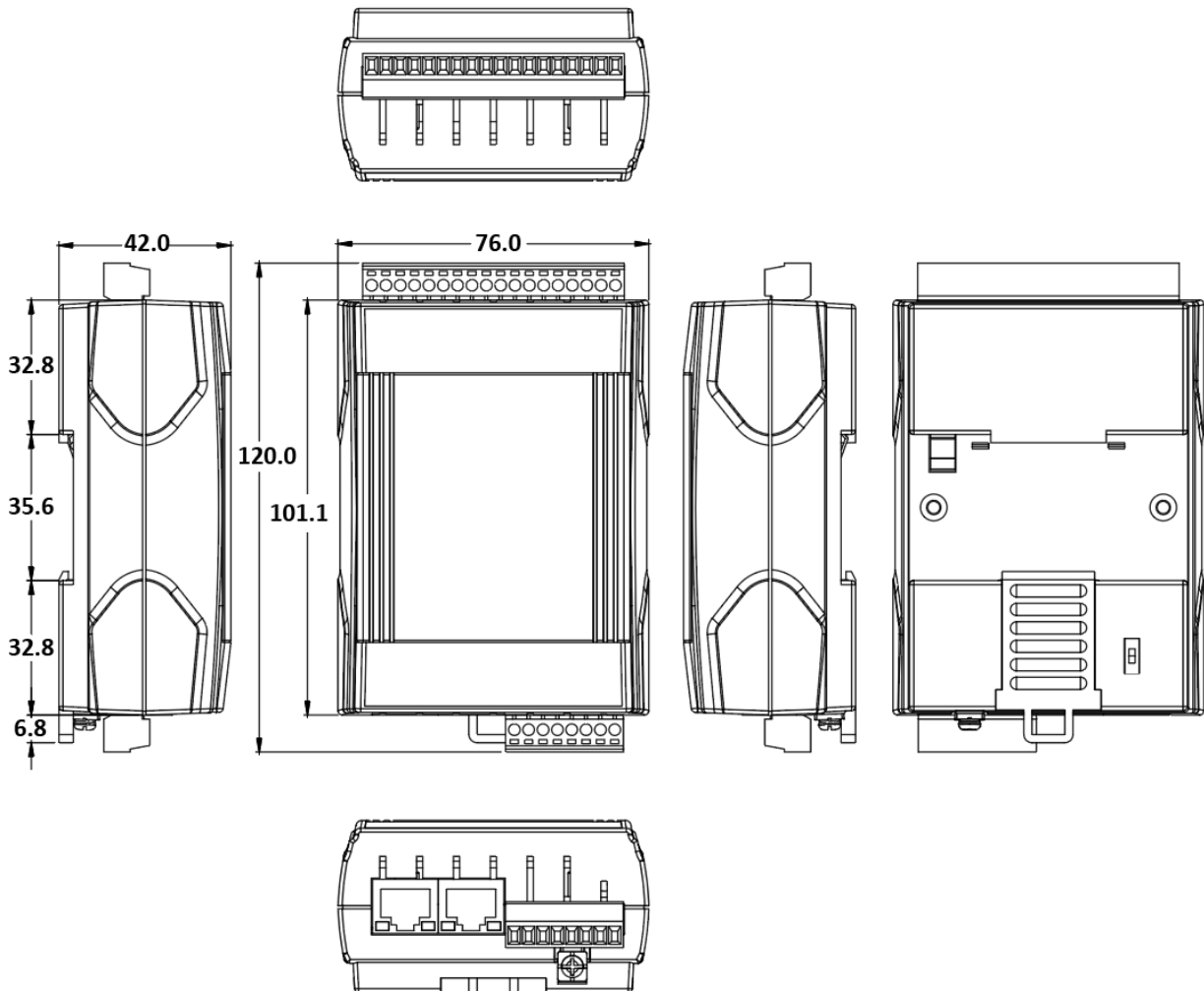

For (P)ET-7258M-16 and (P)ET-7259M-16 Series

Metal Casing: 97 x 130 x 38 (W x L x H)

ET-7258M-16	PET-7258M-16
ET-7258M-16-UTA	PET-7258M-16-UTA
ET-7259M-16	PET-7259M-16
ET-7259M-16-UTA	PET-7259M-16-UTA

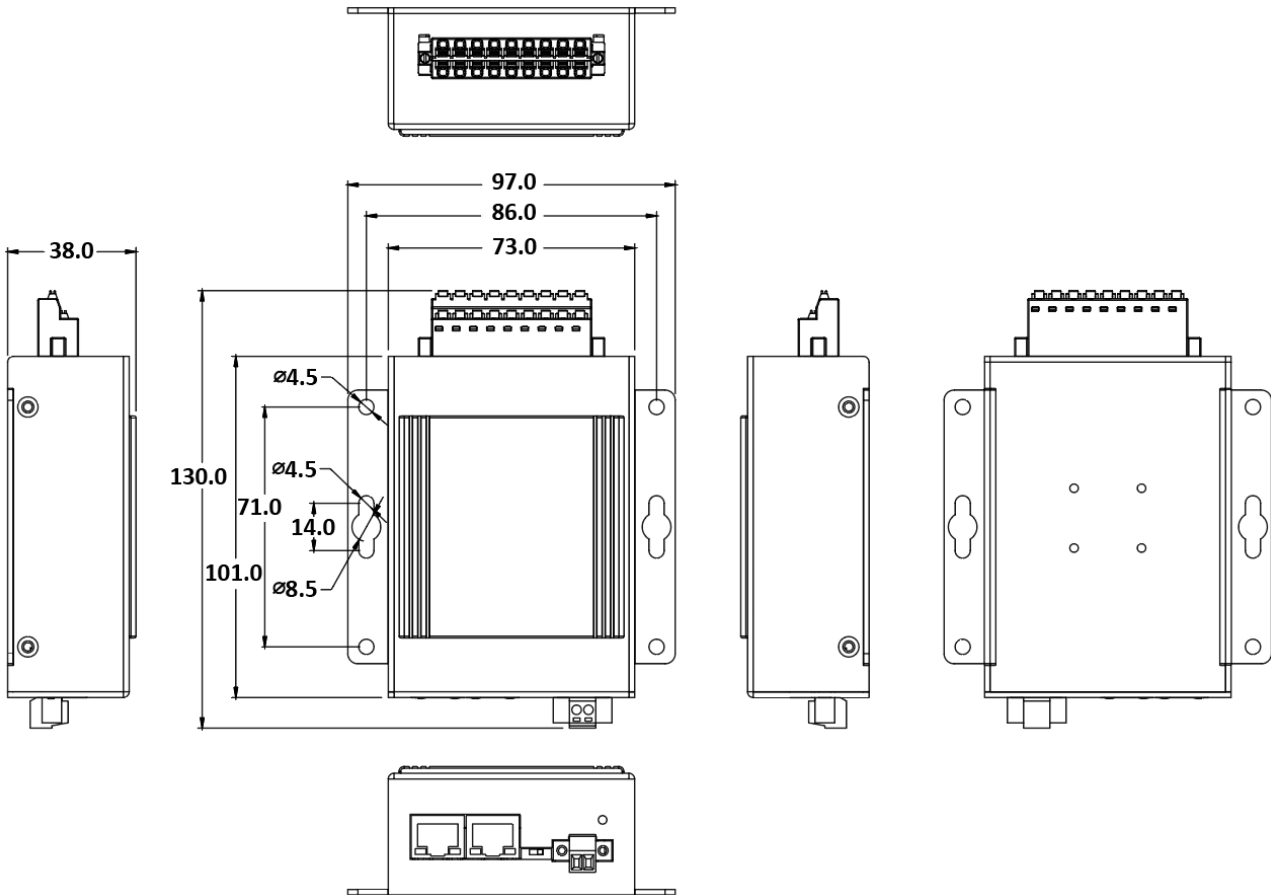

Chapter 2. Getting Started

If you are a new user, begin with this chapter as it includes a guided tour that provides a basic overview of how to install, configure and use the ET-7x00/PET-7x00 module.

<https://www.icpdas.com/en/download/show.php?num=2218>

Before starting any task, please check the package contents. If any of the following items are either missing or damaged, contact your dealer or distributor.

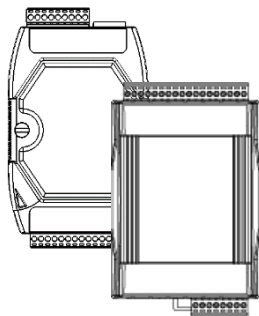

ET-7x00/PET-7x00

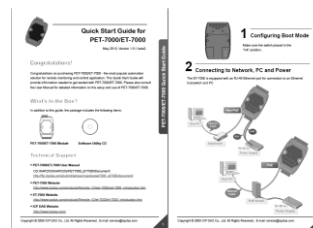

Quick Start Guide

Before operating the ET-7x00/PET-7x00 module, a basic understanding of the hardware specifications is required, such as the dimensions of the module, the usable input voltage range of the power supply, and the type of communication interfaces.

2.1. Mounting the ET-7x00/PET-7x00

The ET-7x00/PET-7x00 module can be mounted by attaching the bottom of the chassis to a DIN-Rail, to the wall, or by piggybacking it to another module.

DIN-Rail Mounting

The ET-7x00/PET-7x00 module includes simple rail clips that can be used to reliably mount it on a standard 35 mm DIN-Rail.

Mounting the Chassis on a DIN-Rail

1. Hook the upper tab over the upper flange of the DIN-Rail.

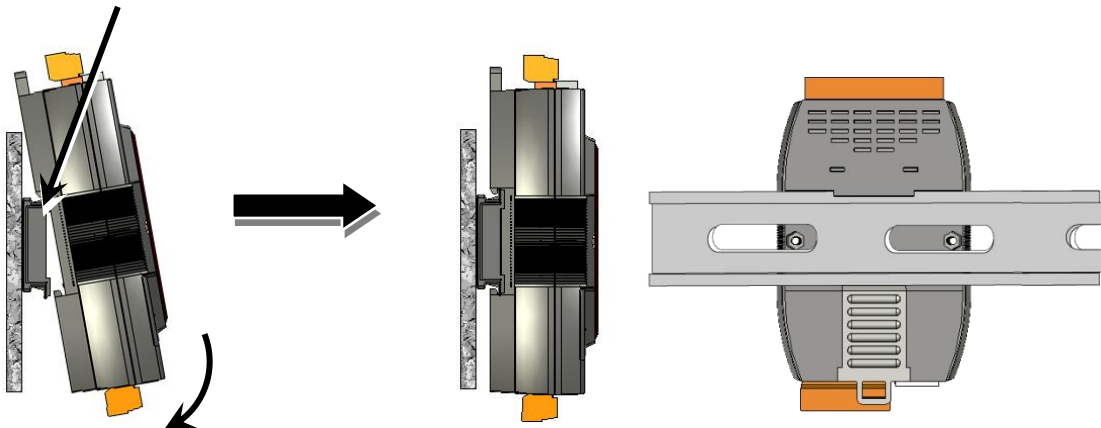

2. Tilt the module toward the DIN-Rail until it snaps securely to the rail.

Piggyback Mounting

The ET-7x00/PET-7x00 module has a hole on either side of the casing that can be used for piggyback mounting.

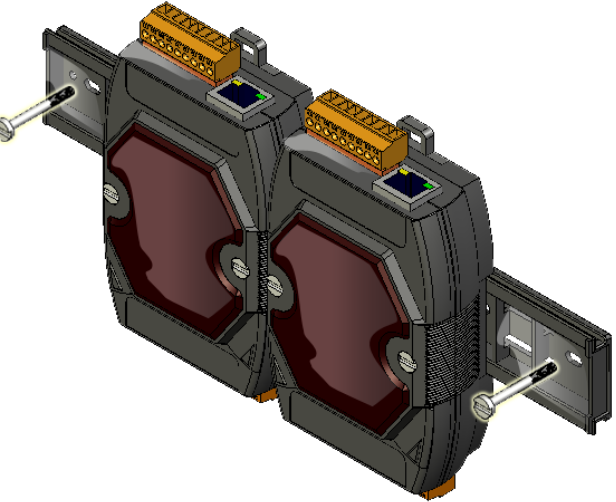

2.2. Configuring the Boot Mode

The ET-7x00/PET-7x00 module has two operating modes, which can be determined by the switch mechanism on the chassis.

Init Mode



Init mode is a way to use MiniOS7 configuration mode.

Tips & Warnings



Init mode is a method to use MiniOS7 configuration mode and update the software. After the update is completed, set the switch to the Normal position.



Normal Mode



Normal mode is the default mode of operation and the one you will use most of the time. Use this mode for more tasks and configurations. Programs also are executed in this mode.

2.3. ET-7x00/PET-7x00 Hardware Connections

ET-7x00/PET-7x00 series modules provide a variety of communication interfaces to suit a range of applications. Below is a description of the configuration for simple applications using the ET-7x00/PET-7x00 when implementing both Non-PoE and PoE solutions.

Non-PoE

1. Connect the PC to the Ethernet Port via the Hub or Switch.
2. Connect the positive of the power supply to the terminal marked “(R)+Vs” on the ET-7x00.
3. Connect the negative of the power supply to the terminal marked “(B)GND” on the ET-7x00.

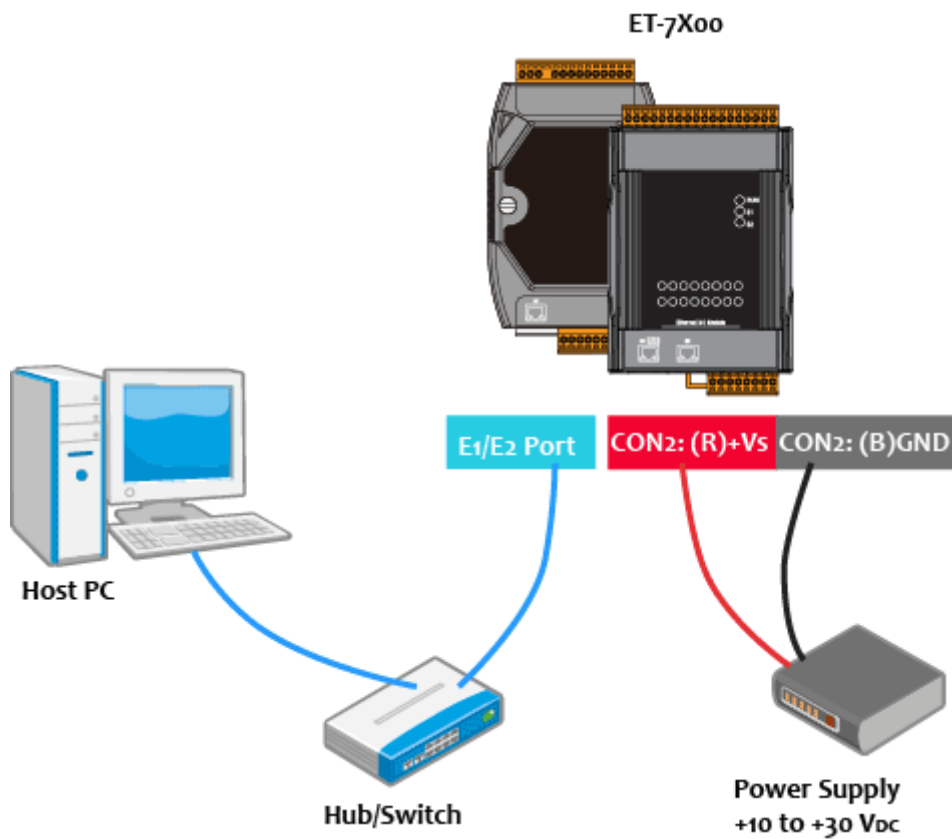

PoE

1. Connect the PC to the Ethernet Port via the PoE Switch.
2. Connect the power supply to the PoE Switch, which in turn supplies power to the PET-7x00.

Tips & Warnings



Only the E1 port of the PET-7x00 supports the PoE feature.

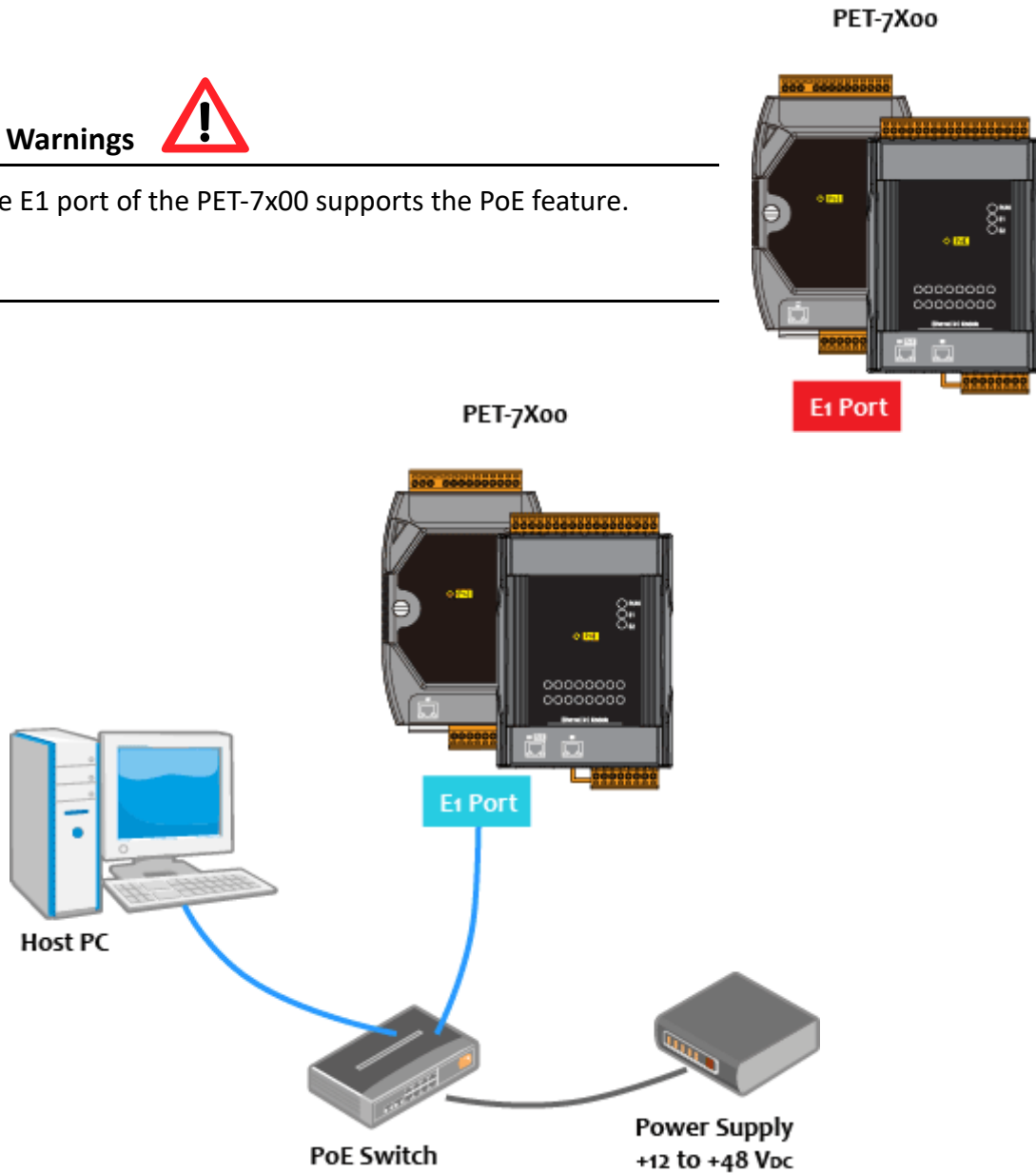

2.4. Installing the MiniOS7 Utility

The MiniOS7 Utility is a useful tool that provides a quick and easy way to update the OS image or the firmware, configure the Ethernet settings, and upload files to the ET-7x00/PET-7x00 from a PC.

Step 1: Install the MiniOS7 Utility tool



The latest version of the MiniOS7 Utility can be obtained from the ICP DAS website:
https://www.icpdas.com/en/product/guide+Software+Development__Tools+MiniOS7

Step 2: Follow the instructions in the Setup Wizard to complete the installation

After the installation has been completed, a new short cut for the MiniOS7 Utility will be displayed on your desktop.

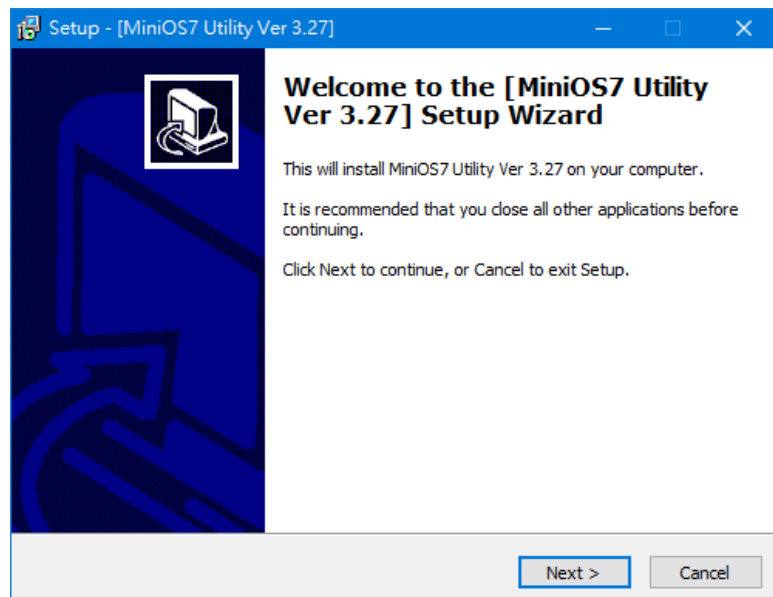
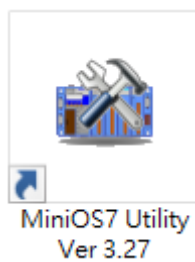

2.5. Using the MiniOS7 Utility to Assign an IP Address

The ET-7x00/PET-7x00 is a web-based device and is configured using a default IP address, meaning that you must first assign a new IP address to the ET-7x00/PET-7x00 before operation.

The factory default IP settings are as follows:

Item	Default
IP Address	192.168.255.1
Subnet Mask	255.255.0.0
Gateway	192.168.0.1

Step 1: Run the MiniOS7 Utility

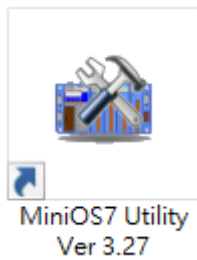

Double-click the “MiniOS7 Utility” shortcut on your desktop.

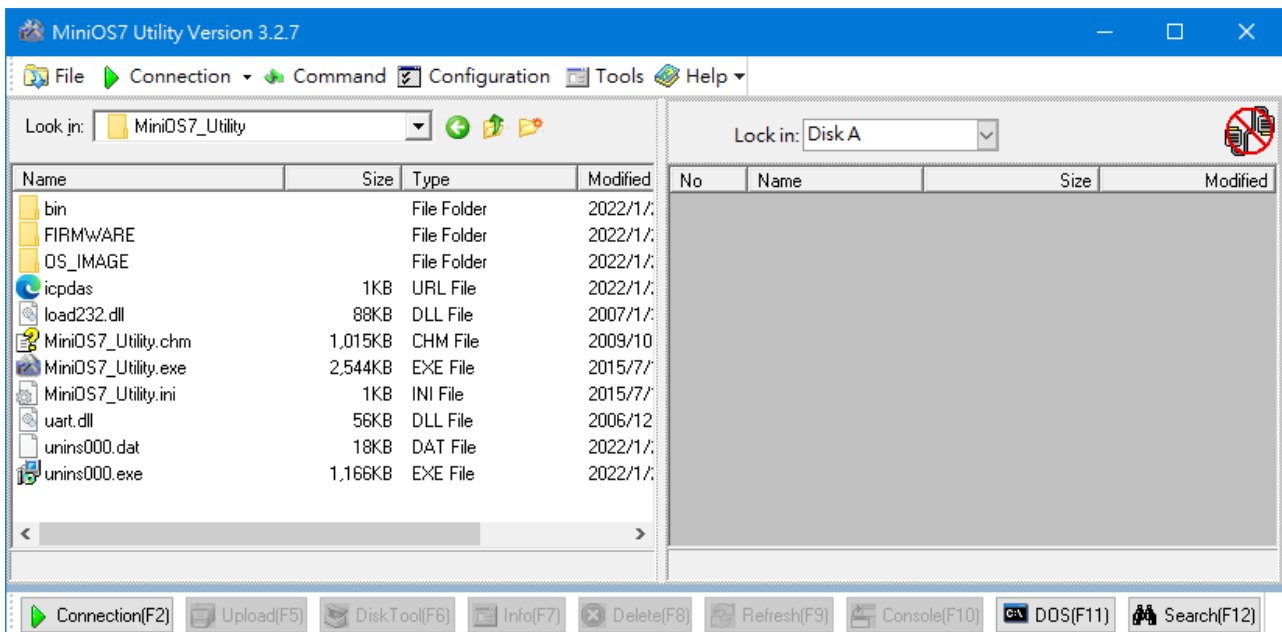

Step 2: Click “Connection > Search” on the menu bar (or press “F12”) to search modules

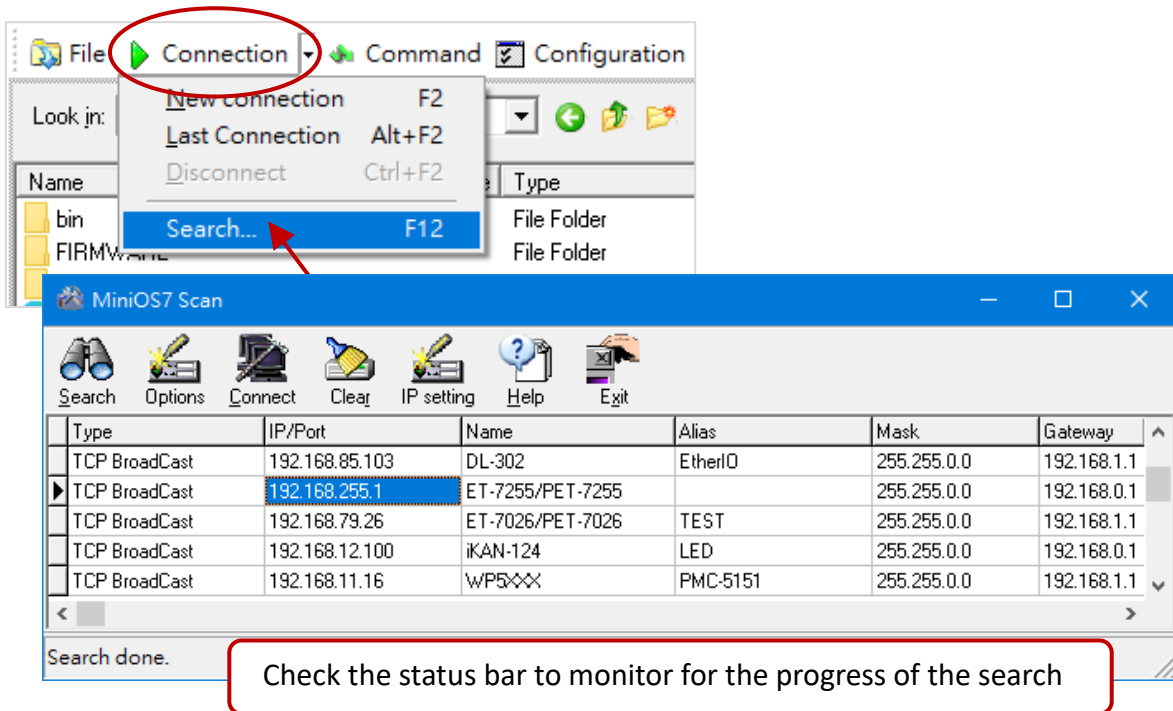

Step 3: Click the “192.168.255.1” item in the IP/Port field and click the “IP Settings” button

Click the item you want to configure (the default IP= “192.168.255.1”) and click the “IP Settings” button to display the IP Settings dialog box.

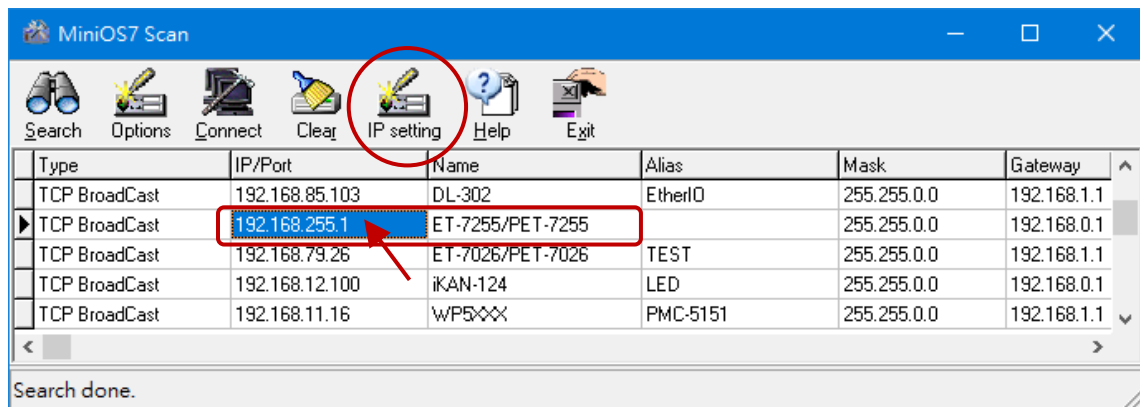

Step 4: Assign a new IP address and then click the “Set” button

In the IP Settings dialog box, you can manually assign an IP Address, Mask Address, Gateway, and Alias, or you can enable the DHCP function to dynamically assign IP addresses. Once the appropriate values have been entered, click the “Set” button to save the settings.

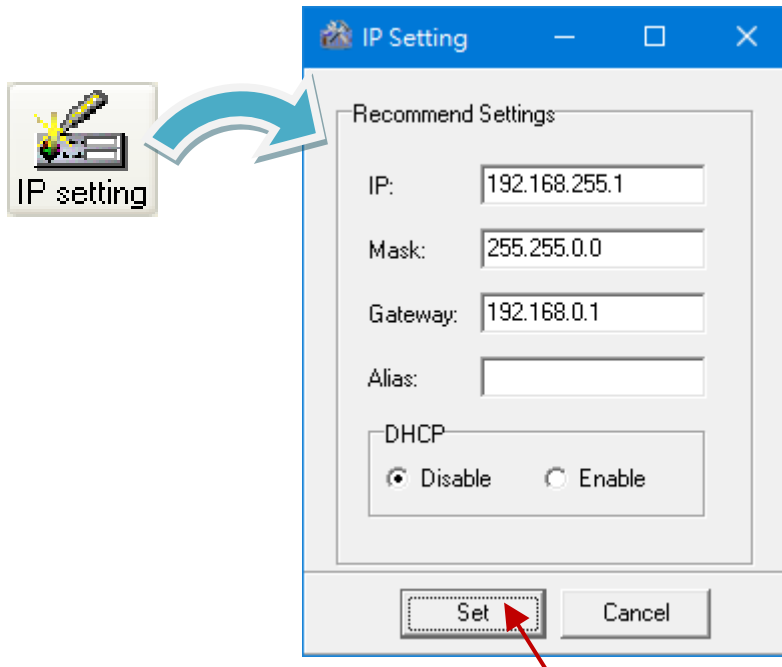

Step 5: After rebooting, click the “Connection > Search” (F12) from the menu bar to check the IP settings

After completing the settings, reboot the module and search it by using MiniOS7 Utility to make sure that the IP settings are correct.

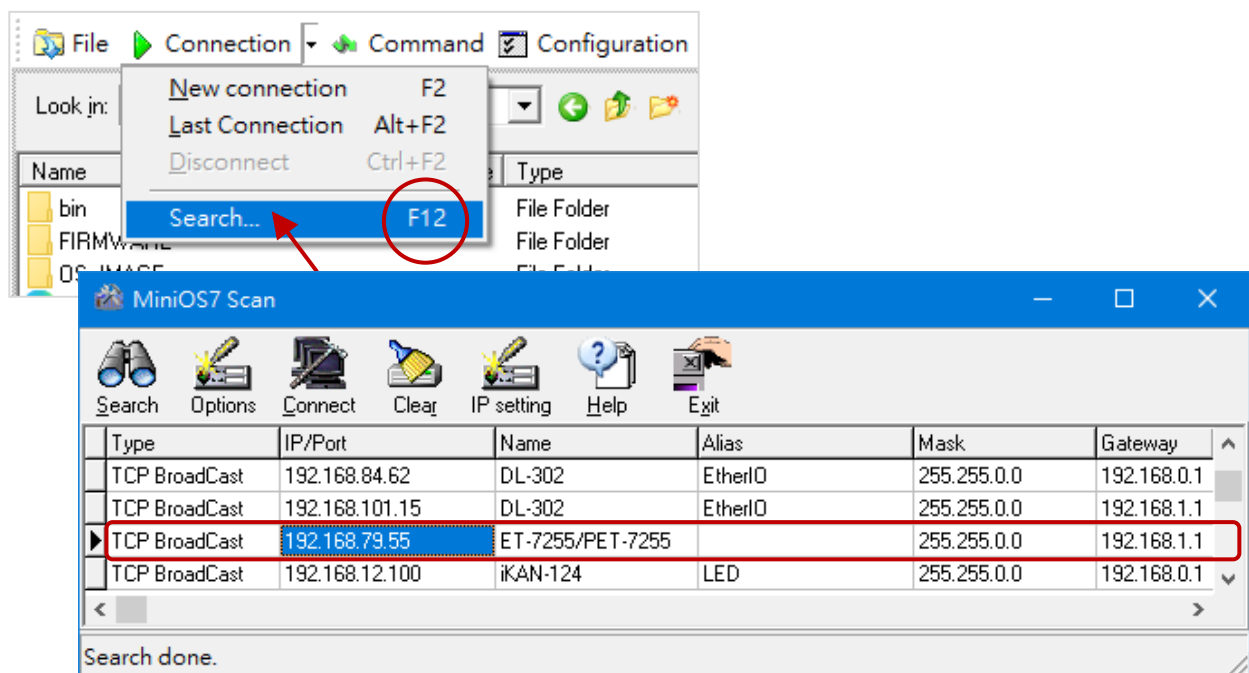

2.6. Configuring the I/O Functions

The ET-7x00/PET-7x00 series provide a web-based configuration interface that allows users to perform module settings and monitor and control the I/O status by using a web browser to log on to the built-in web page. Users do not need to install any utility.

Step 1: Be sure that the switch is set to the “Normal” position and then reboot the module

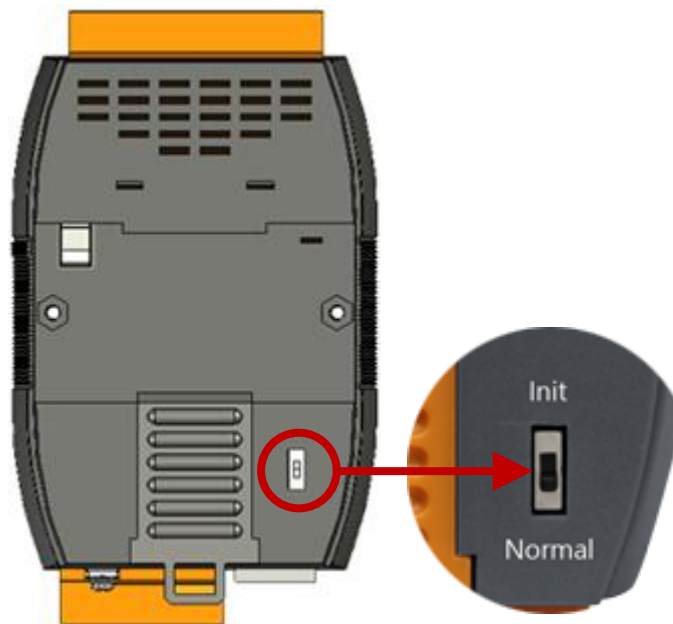

Step 2: Open a browser

Use a standard internet browser to view the ET-7x00/PET-7x00 web pages, such as Google Chrome, Mozilla Firefox or Internet Explorer, etc.

Step 3: Enter the URL address for the ET-7x00/PET-7x00

If you haven't changed the default IP address of the ET-7x00/PET-7x00 module, please refer to section 2.5. "Using the MiniOS7 Utility to Assign an IP Address" to configure it.



Step 4: Enter your User name and Password

After entering the IP address, the login dialog box will appear, prompting you to enter your user name and password.

The factory default user name and password are as follows:

Item	Default
User name	Admin
Password	Admin

Since firmware version V3.11 (or later), the default username and password are not supported. Users need to create them for their initial login.

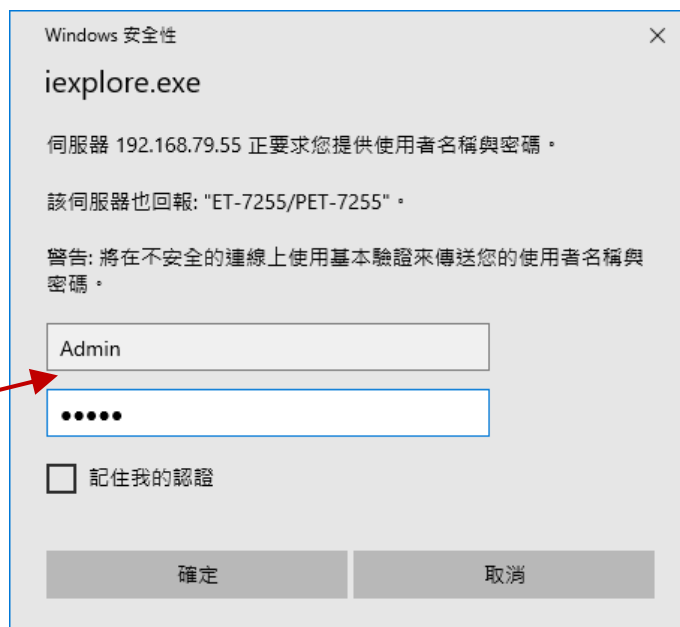

Step 5: Welcome to the ET-7x00/PET-7x00 web interface

After logging into the ET-7x00/PET-7x00 web interface, the Overview page will be displayed.

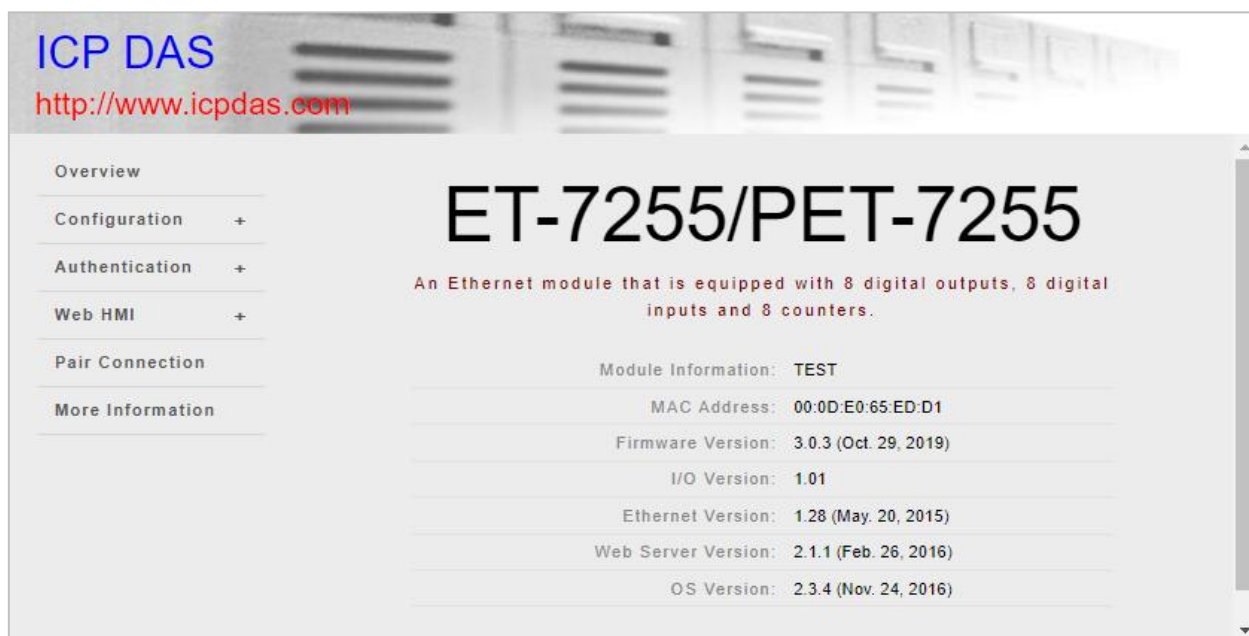

Step 6: Configure and browse the I/O functions

Expand the "Web HMI" menu and click the "Web HMI" item to set and browse the I/O functions.

THIS COMPUTER - - ET-7200

It indicates the network connection between your PC and the module is working fine.



Digital Inputs

Channel No.	Modbus Register	Status	Counter	High Latched	Low Latched
DI0	10000	OFF	-	-	-
DI1	10001	OFF	-	-	-
DI2	10002	OFF	-	-	-
DI3	10003	OFF	-	-	-
DI4	10004	OFF	-	-	-
DI5	10005	OFF	-	-	-
DI6	10006	OFF	-	-	-
DI7	10007	OFF	-	-	-

Digital Outputs

Channel No.	Modbus Register	Status	Action
DO0	00000	ON	<input type="button" value="OFF"/> <input type="button" value="ON"/>
DO1	00001	OFF	<input type="button" value="OFF"/> <input type="button" value="ON"/>
DO2	00002	OFF	<input type="button" value="OFF"/> <input type="button" value="ON"/>
DO3	00003	OFF	<input type="button" value="OFF"/> <input type="button" value="ON"/>
DO4	00004	OFF	<input type="button" value="OFF"/> <input type="button" value="ON"/>
DO5	00005	OFF	<input type="button" value="OFF"/> <input type="button" value="ON"/>
DO6	00006	OFF	<input type="button" value="OFF"/> <input type="button" value="ON"/>
DO7	00007	OFF	<input type="button" value="OFF"/> <input type="button" value="ON"/>

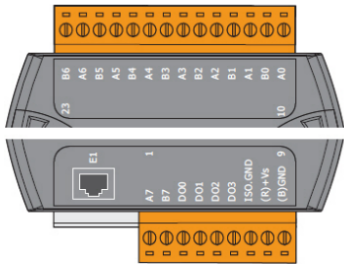
For more information about the I/O specification, pin assignment, I/O functions, etc. for each ET-7x00/PET-7x00, please refer to “ET7000_ET7200 Register Table”, which can be obtained from: <https://www.icpdas.com/en/download/show.php?num=2217>

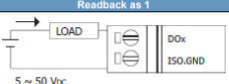
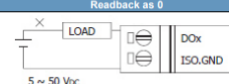
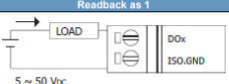
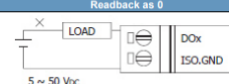
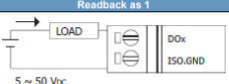
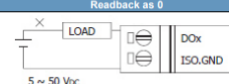
ICP DAS Ethernet I/O Modules		ICP DAS Ethernet I/O Modules																																																																																																																																									
<h3 style="margin: 0;">ET-7005/PET-7005</h3> <p style="margin: 10px 0 0 0;">I/O Specifications</p> <table border="1" style="width: 100%; border-collapse: collapse; font-size: 0.8em;"> <thead> <tr style="background-color: #e6f2ff;"> <th colspan="2">Thermistor Input</th> </tr> </thead> <tbody> <tr> <td>Channels</td> <td>8 (Differential)</td> </tr> <tr> <td>Sensor Type</td> <td>Precon ST-A3, Fenwell U, YSI L100, YSI L300, YSI L1000, YSI B2232, YSI B3000, YSI B5000, YSI B6000, YSI S10000, YSI H10000, YSI H30000, User-defined</td> </tr> <tr> <td>Individual Channel Configuration</td> <td>Yes</td> </tr> <tr> <td>Resolution</td> <td>16-bit</td> </tr> <tr> <td>Sampling Rate</td> <td>10 Samples/Second (Total)</td> </tr> <tr> <td>Accuracy</td> <td>±0.1% or better</td> </tr> <tr> <td>Zero Drift</td> <td>±20 µV/°C</td> </tr> <tr> <td>Span Drift</td> <td>±25 ppm/°C</td> </tr> <tr> <td>Over-voltage Protection</td> <td>110 V_{DC}/V_{AC}</td> </tr> <tr> <td>Common Mode Rejection</td> <td>86 dB</td> </tr> <tr> <td>Normal Mode Rejection</td> <td>100 udB</td> </tr> <tr> <td>Open Wire Detection</td> <td>Yes</td> </tr> <tr style="background-color: #e6f2ff;"> <th colspan="2">Digital Output</th> </tr> <tr> <td>Channels</td> <td>4</td> </tr> <tr> <td>Type</td> <td>Isolated Open Collector</td> </tr> <tr> <td>Sink/Source (NPN/PNP)</td> <td>Sink</td> </tr> <tr> <td>Max. Load Current</td> <td>700 mA/Channel</td> </tr> <tr> <td>Load Voltage</td> <td>5 V_{DC} ~ 50 V_{DC}</td> </tr> <tr> <td>Overvoltage Protection</td> <td>80 V_{DC}</td> </tr> <tr> <td>Overload Protection</td> <td>1.4 A</td> </tr> <tr> <td>Short-circuit Protection</td> <td>Yes</td> </tr> <tr> <td>Power-on Value</td> <td>Yes, Programmable</td> </tr> <tr> <td>Safe Value</td> <td>Yes, Programmable</td> </tr> </tbody> </table> <p style="margin: 10px 0 0 0;">Pin Assignments</p>  <p style="margin: 10px 0 0 0;">Wire Connections</p> <div style="border: 1px solid black; padding: 5px; margin: 5px 0;"> <p style="text-align: center; font-weight: bold; font-size: 0.8em;">Thermistor Input</p>  </div> <table border="1" style="width: 100%; border-collapse: collapse; font-size: 0.8em; margin: 5px 0;"> <thead> <tr style="background-color: #e6f2ff;"> <th style="width: 30%;"></th> <th style="width: 35%;">ON State Readback as 1</th> <th style="width: 35%;">ON State Readback as 0</th> </tr> </thead> <tbody> <tr> <td style="text-align: center; vertical-align: middle;">Open Collector (Sink)</td> <td style="text-align: center;">  </td> <td style="text-align: center;">  </td> </tr> </tbody> </table>		Thermistor Input		Channels	8 (Differential)	Sensor Type	Precon ST-A3, Fenwell U, YSI L100, YSI L300, YSI L1000, YSI B2232, YSI B3000, YSI B5000, YSI B6000, YSI S10000, YSI H10000, YSI H30000, User-defined	Individual Channel Configuration	Yes	Resolution	16-bit	Sampling Rate	10 Samples/Second (Total)	Accuracy	±0.1% or better	Zero Drift	±20 µV/°C	Span Drift	±25 ppm/°C	Over-voltage Protection	110 V _{DC} /V _{AC}	Common Mode Rejection	86 dB	Normal Mode Rejection	100 udB	Open Wire Detection	Yes	Digital Output		Channels	4	Type	Isolated Open Collector	Sink/Source (NPN/PNP)	Sink	Max. Load Current	700 mA/Channel	Load Voltage	5 V _{DC} ~ 50 V _{DC}	Overvoltage Protection	80 V _{DC}	Overload Protection	1.4 A	Short-circuit Protection	Yes	Power-on Value	Yes, Programmable	Safe Value	Yes, Programmable		ON State Readback as 1	ON State Readback as 0	Open Collector (Sink)			<p style="margin: 0;">Modbus Register Table</p> <p style="margin: 5px 0 0 0;">Coils (0xxxx)</p> <table border="1" style="width: 100%; border-collapse: collapse; font-size: 0.8em;"> <thead> <tr style="background-color: #e6f2ff;"> <th colspan="2">Register</th> <th rowspan="2">Points</th> <th rowspan="2">Description</th> </tr> <tr style="background-color: #e6f2ff;"> <th>DEC</th> <th>HEX</th> </tr> </thead> <tbody> <tr> <td>00000 : 00003</td> <td>0000 : 0003</td> <td>4</td> <td>DO value</td> </tr> <tr> <td>00162 : 00169</td> <td>00A2 : 00A9</td> <td>8</td> <td>Clear 1-ch historical AI max. value</td> </tr> <tr> <td>00194 : 00201</td> <td>00C2 : 00C9</td> <td>8</td> <td>Clear 1-ch historical AI min. value</td> </tr> <tr> <td>00226</td> <td>00E2</td> <td>1</td> <td>Reset the I/O settings to the factory default state</td> </tr> <tr> <td>00233</td> <td>00E9</td> <td>1</td> <td>Reboot module</td> </tr> <tr> <td>00431</td> <td>01AF</td> <td>1</td> <td>Save the DO power-on value to the EEPROM</td> </tr> <tr> <td>00432</td> <td>01B0</td> <td>1</td> <td>Save the DO safe value to the EEPROM</td> </tr> <tr> <td>00435 : 00438</td> <td>01B3 : 01B6</td> <td>4</td> <td>Enable/Disable the DO power-on value function</td> </tr> <tr> <td>00515 : 00518</td> <td>0203 : 0206</td> <td>4</td> <td>Enable/Disable the DO safe value function</td> </tr> <tr> <td>00595 : 00602</td> <td>0253 : 025A</td> <td>8</td> <td>Enable/Disable the AI function</td> </tr> <tr> <td>00627</td> <td>0273</td> <td>1</td> <td>Set the temperature scale</td> </tr> <tr> <td>00631</td> <td>0277</td> <td>1</td> <td>Set the AI data format</td> </tr> <tr> <td>00632</td> <td>0278</td> <td>1</td> <td>Reset the AI calibration to the factory settings</td> </tr> <tr> <td>00634</td> <td>027A</td> <td>1</td> <td>Clear all historical AI max. values</td> </tr> <tr> <td>00635</td> <td>027B</td> <td>1</td> <td>Clear all historical AI min. values</td> </tr> <tr> <td>00636 : 00643</td> <td>027C : 0283</td> <td>8</td> <td>Enable/Disable the AI high alarm function</td> </tr> <tr> <td>00668 : 00675</td> <td>029C : 02A3</td> <td>8</td> <td>Enable/Disable the AI low alarm function</td> </tr> <tr> <td>00700 : 00707</td> <td>02BC : 02C3</td> <td>8</td> <td>Set the AI high alarm mode</td> </tr> <tr> <td>00732</td> <td>02DC</td> <td></td> <td></td> </tr> </tbody> </table>		Register		Points	Description	DEC	HEX	00000 : 00003	0000 : 0003	4	DO value	00162 : 00169	00A2 : 00A9	8	Clear 1-ch historical AI max. value	00194 : 00201	00C2 : 00C9	8	Clear 1-ch historical AI min. value	00226	00E2	1	Reset the I/O settings to the factory default state	00233	00E9	1	Reboot module	00431	01AF	1	Save the DO power-on value to the EEPROM	00432	01B0	1	Save the DO safe value to the EEPROM	00435 : 00438	01B3 : 01B6	4	Enable/Disable the DO power-on value function	00515 : 00518	0203 : 0206	4	Enable/Disable the DO safe value function	00595 : 00602	0253 : 025A	8	Enable/Disable the AI function	00627	0273	1	Set the temperature scale	00631	0277	1	Set the AI data format	00632	0278	1	Reset the AI calibration to the factory settings	00634	027A	1	Clear all historical AI max. values	00635	027B	1	Clear all historical AI min. values	00636 : 00643	027C : 0283	8	Enable/Disable the AI high alarm function	00668 : 00675	029C : 02A3	8	Enable/Disable the AI low alarm function	00700 : 00707	02BC : 02C3	8	Set the AI high alarm mode	00732	02DC		
Thermistor Input																																																																																																																																											
Channels	8 (Differential)																																																																																																																																										
Sensor Type	Precon ST-A3, Fenwell U, YSI L100, YSI L300, YSI L1000, YSI B2232, YSI B3000, YSI B5000, YSI B6000, YSI S10000, YSI H10000, YSI H30000, User-defined																																																																																																																																										
Individual Channel Configuration	Yes																																																																																																																																										
Resolution	16-bit																																																																																																																																										
Sampling Rate	10 Samples/Second (Total)																																																																																																																																										
Accuracy	±0.1% or better																																																																																																																																										
Zero Drift	±20 µV/°C																																																																																																																																										
Span Drift	±25 ppm/°C																																																																																																																																										
Over-voltage Protection	110 V _{DC} /V _{AC}																																																																																																																																										
Common Mode Rejection	86 dB																																																																																																																																										
Normal Mode Rejection	100 udB																																																																																																																																										
Open Wire Detection	Yes																																																																																																																																										
Digital Output																																																																																																																																											
Channels	4																																																																																																																																										
Type	Isolated Open Collector																																																																																																																																										
Sink/Source (NPN/PNP)	Sink																																																																																																																																										
Max. Load Current	700 mA/Channel																																																																																																																																										
Load Voltage	5 V _{DC} ~ 50 V _{DC}																																																																																																																																										
Overvoltage Protection	80 V _{DC}																																																																																																																																										
Overload Protection	1.4 A																																																																																																																																										
Short-circuit Protection	Yes																																																																																																																																										
Power-on Value	Yes, Programmable																																																																																																																																										
Safe Value	Yes, Programmable																																																																																																																																										
	ON State Readback as 1	ON State Readback as 0																																																																																																																																									
Open Collector (Sink)																																																																																																																																											
Register		Points	Description																																																																																																																																								
DEC	HEX																																																																																																																																										
00000 : 00003	0000 : 0003	4	DO value																																																																																																																																								
00162 : 00169	00A2 : 00A9	8	Clear 1-ch historical AI max. value																																																																																																																																								
00194 : 00201	00C2 : 00C9	8	Clear 1-ch historical AI min. value																																																																																																																																								
00226	00E2	1	Reset the I/O settings to the factory default state																																																																																																																																								
00233	00E9	1	Reboot module																																																																																																																																								
00431	01AF	1	Save the DO power-on value to the EEPROM																																																																																																																																								
00432	01B0	1	Save the DO safe value to the EEPROM																																																																																																																																								
00435 : 00438	01B3 : 01B6	4	Enable/Disable the DO power-on value function																																																																																																																																								
00515 : 00518	0203 : 0206	4	Enable/Disable the DO safe value function																																																																																																																																								
00595 : 00602	0253 : 025A	8	Enable/Disable the AI function																																																																																																																																								
00627	0273	1	Set the temperature scale																																																																																																																																								
00631	0277	1	Set the AI data format																																																																																																																																								
00632	0278	1	Reset the AI calibration to the factory settings																																																																																																																																								
00634	027A	1	Clear all historical AI max. values																																																																																																																																								
00635	027B	1	Clear all historical AI min. values																																																																																																																																								
00636 : 00643	027C : 0283	8	Enable/Disable the AI high alarm function																																																																																																																																								
00668 : 00675	029C : 02A3	8	Enable/Disable the AI low alarm function																																																																																																																																								
00700 : 00707	02BC : 02C3	8	Set the AI high alarm mode																																																																																																																																								
00732	02DC																																																																																																																																										

Chapter 3. Web Applications

The ET-7x00/PET-7x00 contains an advanced web configuration system that provides users with access to ET-7x00/PET-7x00 applications through a standard web browser.

Logging into the ET-7x00/PET-7x00 web pages

You can log into the ET-7x00/PET-7x00 web pages from any computer that has Internet access.

Step 1: Open a browser

Use a standard internet browser to view the ET-7x00/PET-7x00 web pages, such as Mozilla Firefox or Internet Explorer, etc.

Step 2: Enter the URL address for the ET-7x00/PET-7x00

If you haven't changed the default IP address of the ET-7x00/PET-7x00 module, please refer to section 2.5. "Using the MiniOS7 Utility to Assign an IP Address" to configure it.

Step 3: Enter your User name and Password

After entering the IP address, the login dialog box will appear, prompting you to enter your user name and password.

The factory default user name and password are as follows:

Item	Default
User name	Admin
Password	Admin

Since firmware version V3.11 (or later), the default username and password are not supported. Users need to create them for their initial login.

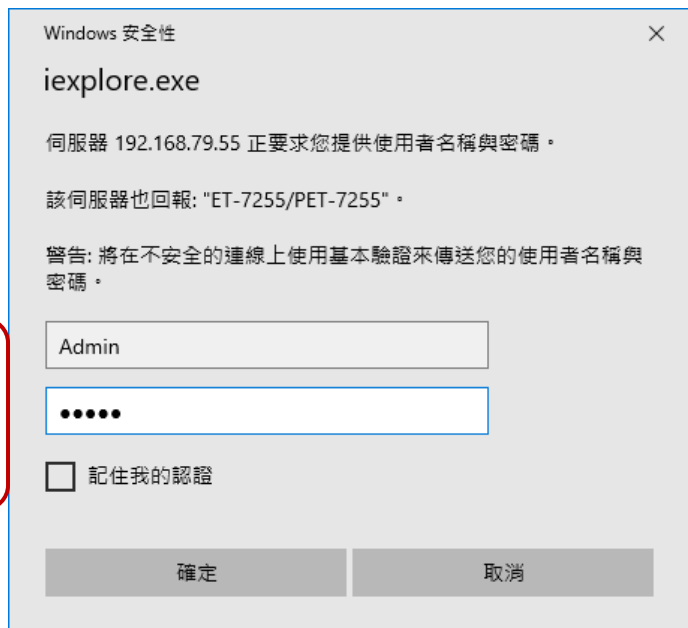

Step 4: Welcome to the ET-7x00/PET-7x00 web interface

After logging into the ET-7x00/PET-7x00 web interface, the “Overview” page will be displayed.

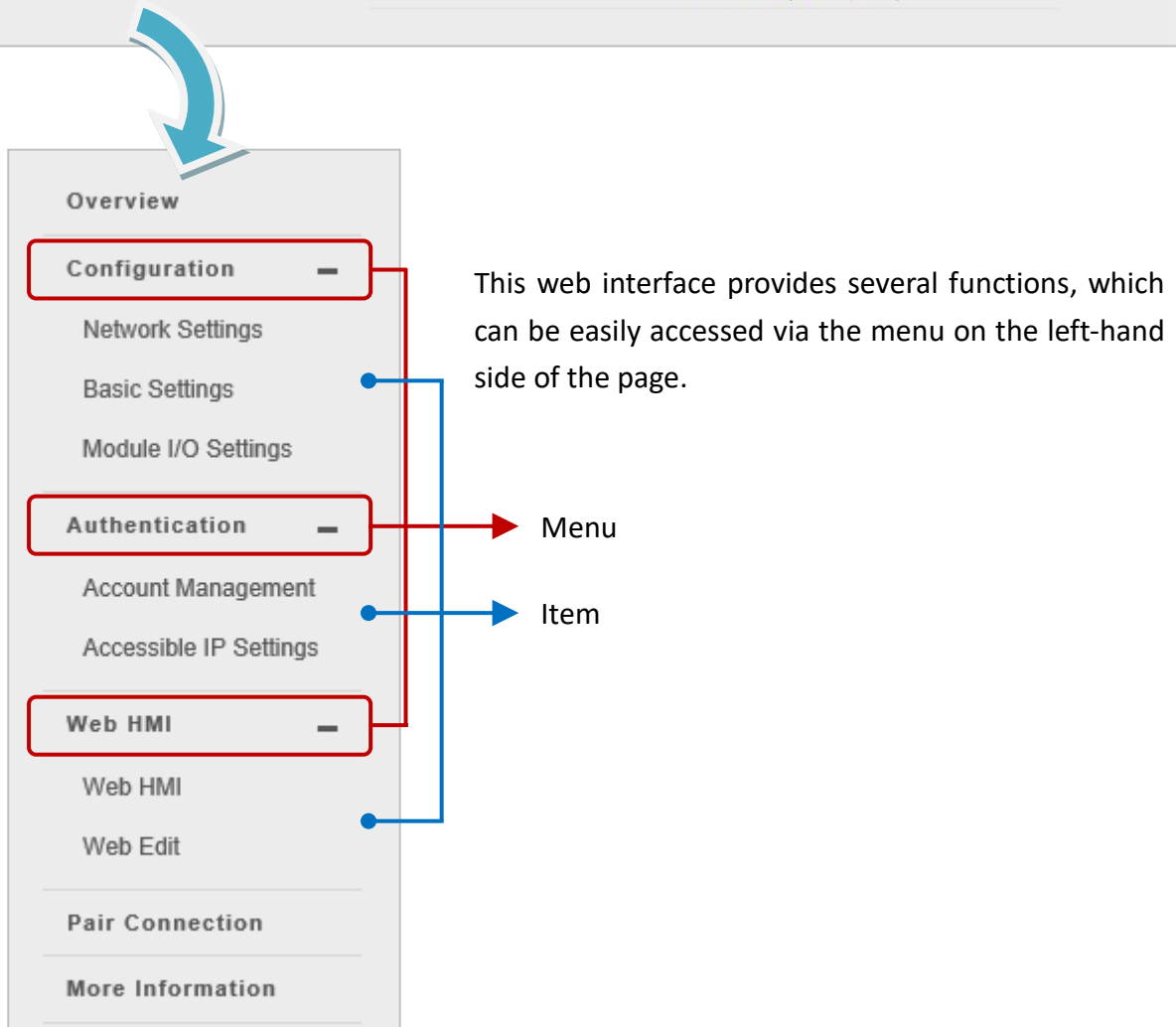
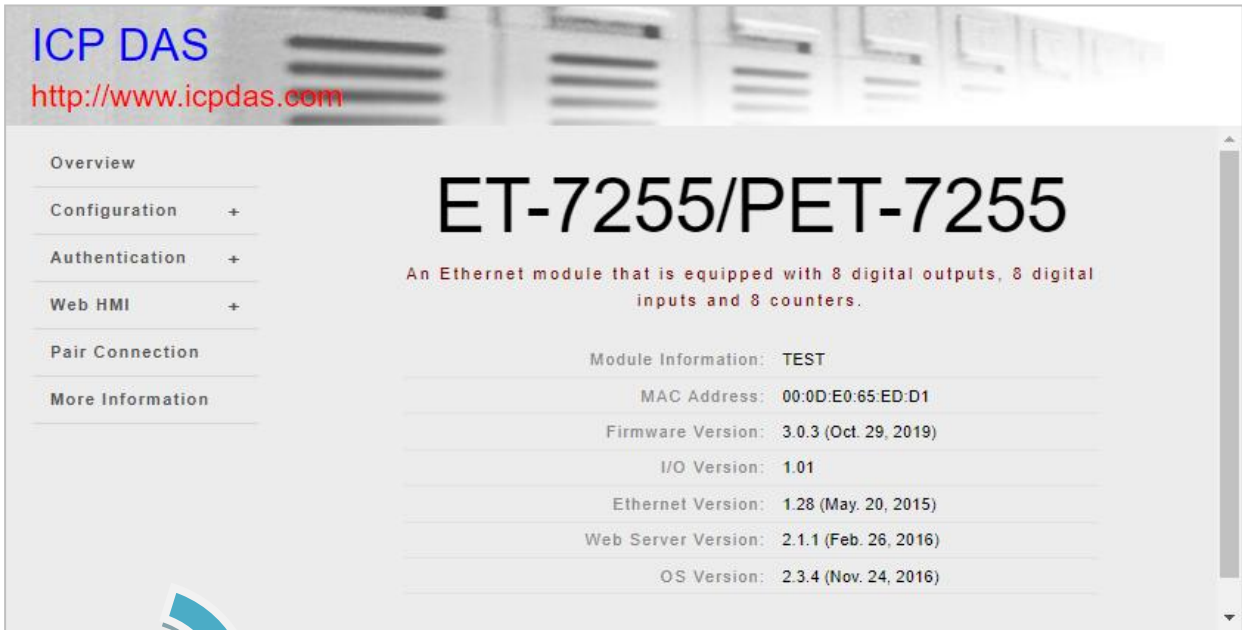

3.1. Overview

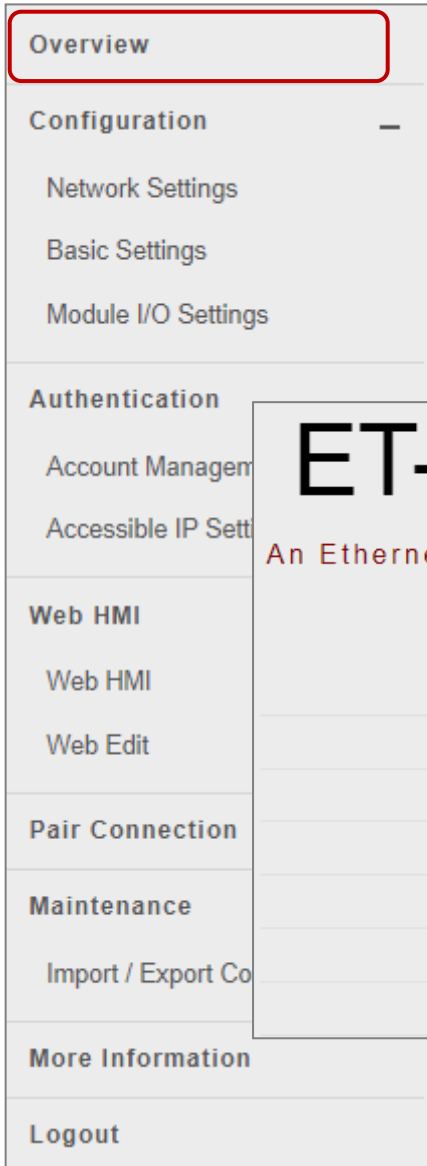

The “Overview” page provides a brief introduction and explanation of the module.

The page provides some basic information about both the ET-7x00/PET-7x00 hardware and software.

ET-7005 / PET-7005

An Ethernet module that is equipped with 4 digital outputs and 8 analog inputs.

Module Information:	
MAC Address:	00:0D:E0:66:84:2A
Firmware Version:	3.1.1 (Sep. 27, 2023)
I/O Version:	4.05
Ethernet Version:	1.29 (Feb. 25, 2019)
Web Server Version:	2.10.4 (Jul. 18, 2023)
OS Version:	2.4.0 (Nov. 24, 2016)

3.2. Configuration

The “Configuration” menu includes the following settings:

Overview
Configuration —
Network Settings
Basic Settings
Module I/O Settings
Authentication —
Account Management
Accessible IP Settings
Web HMI —
Web HMI
Web Edit
Pair Connection
Maintenance —
Import / Export Configuration
More Information
Logout

Network Settings:

Provides access to the **Ethernet Configuration** section which allows you to access the IP settings and check the software version.

Basic Settings:

Provides access to the **Basic Settings** section which allows you to configure the basic information for the web interface. Also, the **Restore All Default Settings** section allows you to reset the module to factory settings.

Module I/O Settings:

Provides access to **Common Functions**, **Modbus Definition**, and I/O-related sections, which allows you to configure the I/O settings of the module.

3.2.1. Network Settings

The **Network Settings** page provides the **Ethernet Configuration** section that allows you to perform the following functions:

The screenshot shows the 'Ethernet Configuration' section of a web interface. At the top, there is a dropdown menu labeled 'Configure:' with 'Manually' selected. Below this are three input fields: 'IP address' containing '192.168.79.55', 'Subnet mask' containing '255.255.0.0', and 'Gateway' containing '192.168.1.1'. A 'SUBMIT' button is located at the bottom center of the form.

✧ **Manual Configuration (Manually):**

The user can enter the IP, Mask, and Gateway addresses for the module and then click the **SUBMIT** button to finish the setting.

IP address:

Each ET-7x00/PET-7x00 on the network must have a unique IP address.

Subnet mask:

The subnet mask splits the IP address into the host and network addresses, thereby defining which part of the IP address belongs to the device and which part belongs to the network.

Gateway:

A gateway (or router) can be used to connect local devices to other networks.

✧ **Dynamic Configuration (Using DHCP):**

The Dynamic Host Configuration Protocol (DHCP) is a network application protocol that automatically assigns an IP address to a device. The user can choose **Using DHCP** in the **Configure** drop-down menu and click the **SUBMIT** button to finish the setting.

3.2.2. Basic Settings

The **Basic Settings** page provides **Basic Settings** and **Restore All Default Setting** sections that allow you to perform the following functions.

(A) Basic Settings

The screenshot shows the 'Basic Settings' configuration page. A red rounded rectangle labeled 'A.' encompasses the 'Module Name' field (ET-7255/PET-7255) and the 'Module Information' field (TEST). A second red circle labeled 'B.' highlights the 'Page Header Information (First line)' section, which includes a text input (ICP DAS), a color dropdown (Blue), and a font size dropdown (7). Other fields include 'Page Header Information (Second line)', 'More Information URL', 'Web Server Port' (80), 'Modbus TCP Port' (502), and 'Modbus TCP Port (WAN)' (502). A 'SUBMIT' button is located at the bottom center.

✧ **Configure the module information**

Module Name:

The initial value for this field will depend on the model of the module and cannot be modified.

Module Information:

The module information field indicates the name of the alias that is used to identify the module.

✧ **Configure the web interface information**

Page Header Information (First line) and Page Header Information (Second line):

The title of the website is displayed in the top left-hand corner of the interface, for example, the company name and web address as per the example below.

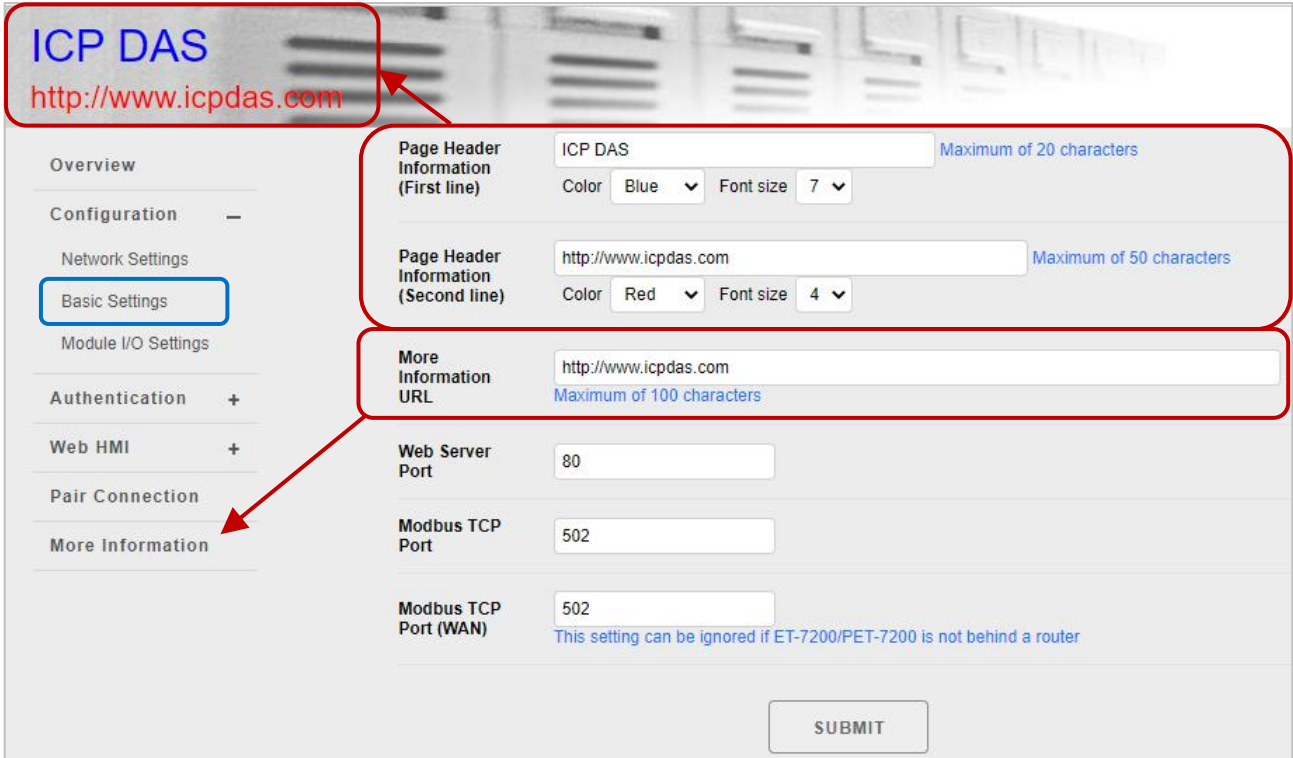

More Information URL:

This item allows you to specify the URL that will be displayed when the “**More Information**” option is clicked to provide additional support for the ET-7x00/PET-7x00.

After completing the settings and refreshing the web page (F5), click the “**More Information**” option to check that the link to the web site is correct as the figure below.

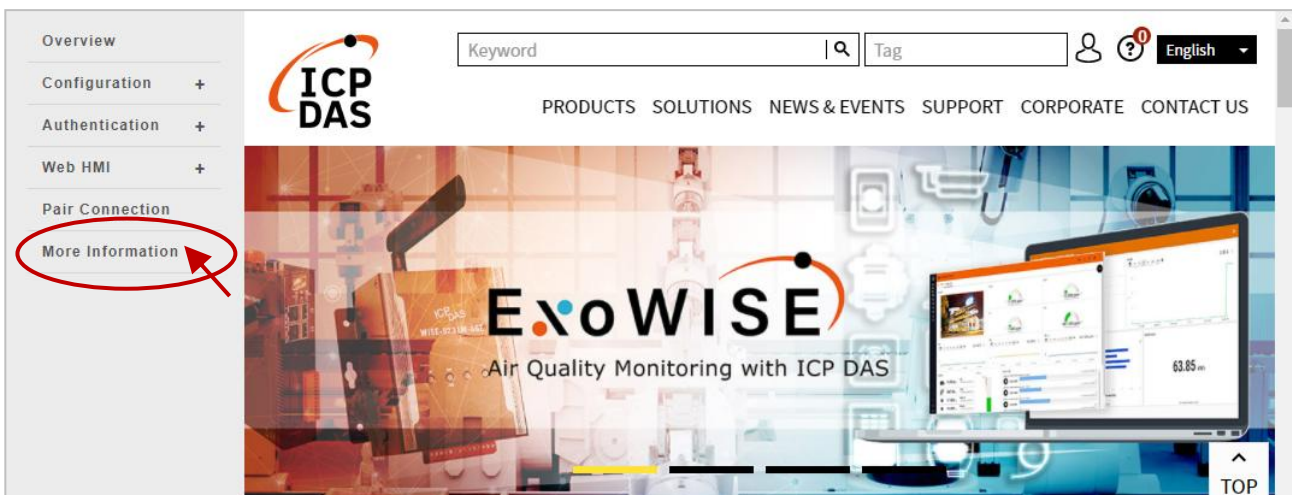

Web Server Port:

This option specifies which port is to be used for the web server. By default, the HTTP port is 80.

Modbus TCP Port:

This option specifies which port is to be used for communication on the Modbus TCP. By default, the Modbus protocol uses port 502.

Modbus TCP Port (WAN):

This option specifies which port is to be used for Modbus communication between the remote host and local EX-7x00/PET-7x00. This setting can be ignored if ET-7x00/PET-7x00 is not located behind a router.

To configure the web interface information, follow the procedure below:

Step 1: Enter the desired information into the respective fields.

Step 2: Click the “Submit” button to finish configuring the module information.

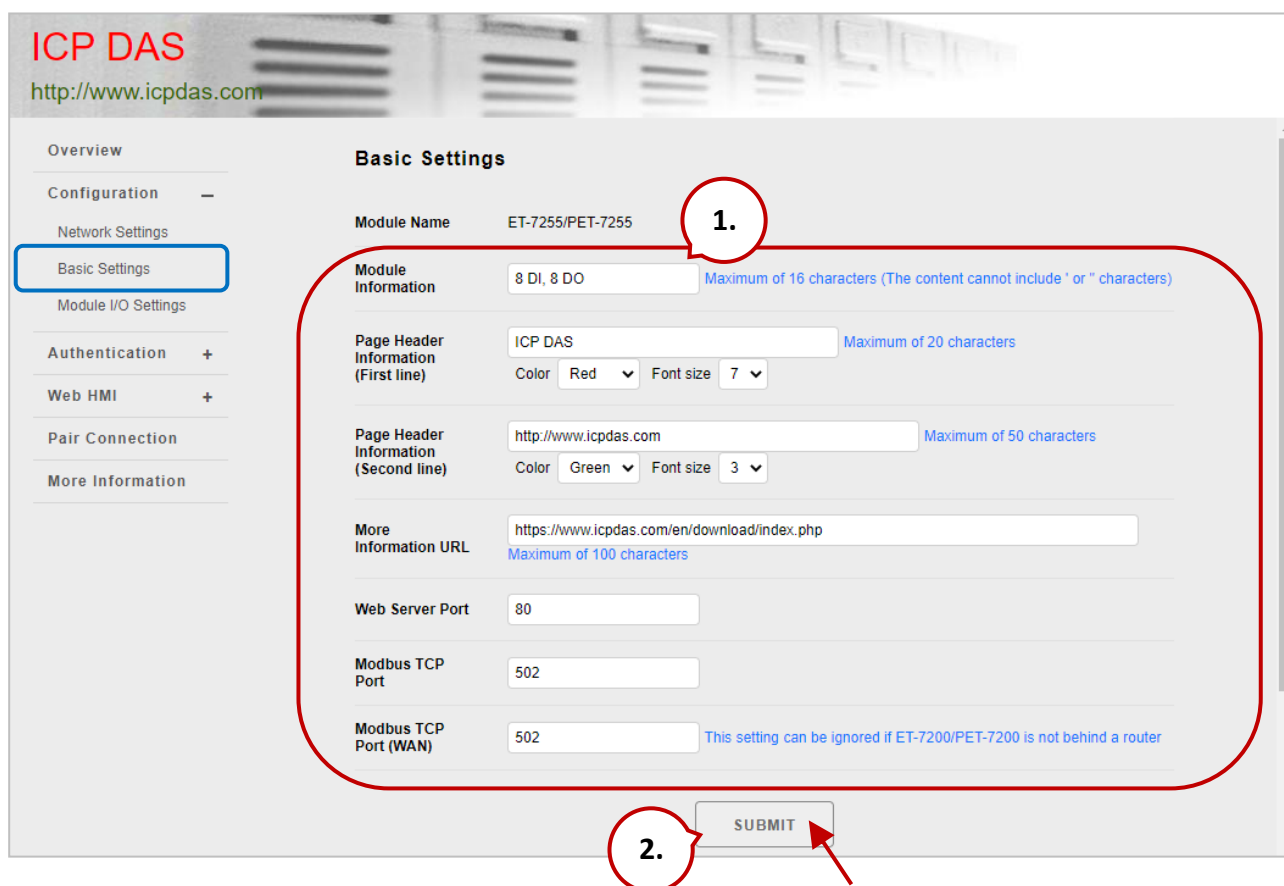

(B) Restore All Default Settings

The reset function is divided into categories based on the menu options for the web interface and can be used to restore the individual settings to their factory default state.

To reset the settings to their factory default, follow the procedure below:

Step 1: Check the relevant check boxes for the items you wish to reset.

Step 2: Click the “Submit” button to reset the settings to their factory default state.

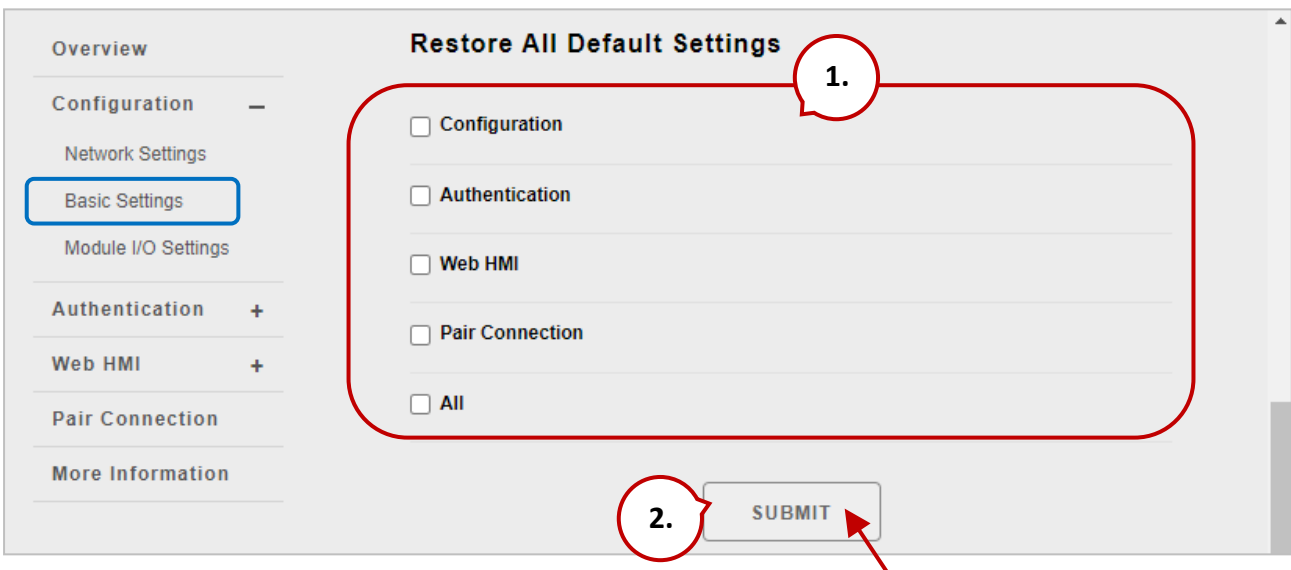

Tips & Warnings

For ET-7200/PET-7200 modules, in addition to using the reset function in the web-based **Basic Settings** page, you can also press and hold the reset button for five seconds to restore the ET-7200/PET-7200 to factory defaults.

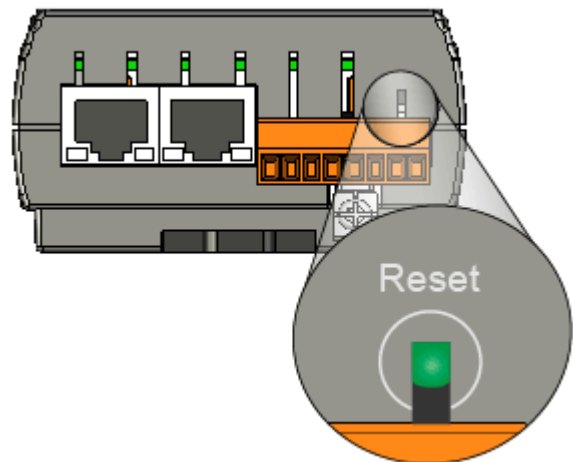

(B.1) Factory Default Settings for the “Configuration” Menu Options

The tables below outline the factory default settings for the items listed in the “Configuration” menu.

Network Settings

Ethernet Configuration

Item	Factory Default Settings
IP Address	192.168.255.1
Subnet Mask	255.255.0.0
Gateway	192.168.0.1

Basic Settings

Basic Settings

Item	Factory Default Settings
Module Name	Depends on the name of the module
Module Information	Empty
Page Header Information (First line)	ICP DAS
Page Header Information (Second line)	https://www.icpdas.com
More Information URL	https://www.icpdas.com
Web Server Port	80
Modbus TCP Port	502
Modbus TCP Port (WAN)	502

Module I/O Settings

Note that all settings displayed on this page vary depending on the model number.

Common Functions

Item	Factory Default Settings
Host Watchdog Timeout	0 (0: Disabled, 1 ~ 65535: Enabled) (units: 0.1 seconds)

Modbus Definition

Item	Factory Default Settings
Modbus Unit ID	1

Digital Output Settings

Item	Factory Default Settings
Power-on Value	OFF
Safe Value	OFF

Digital Input Settings

Item	Factory Default Settings
DI Latched Status	Disabled
Digital Input Counter	Disabled
Counter Value Inverse	Disabled
Low-Pass Filter	100 Hz. The Min. width is 5 ms

Analog Output Settings

Item	Factory Default Settings
Range	This value varies depending on the model of the module
Slew Rate	00, Immediate
Power-on Value	0.0
Safe Value	0.0

Analog Input Settings

Item	Factory Default Settings	
Channel	Enable	
Range	This value varies depending on the model of the module	
Sampling Rate	Normal mode (10 Hz)	Normal mode
	Fast mode (50 Hz)	
Filter Setting	60 Hz Rejection	60 Hz Rejection
	50 Hz Rejection	
Data Format	HEX 2's complement	HEX 2's complement
	Engineering	

Note: The analog input and the analog output share the same data format settings.

Alarm Settings

Item	Factory Default Settings	
High Alarm	Channel	Disable
	High Limit Value	This value varies depending on the model of the module
	Mode	Momentary
Low Alarm	Channel	Disable
	Low Limit Value	This value varies depending on the model of the module
	Mode	Momentary

(B.2) Factory Default Settings for the “Authentication” Menu Options

The tables below outline the factory default settings for the items listed in the “Authentication” menu.

Account Management

Privilege Management

Item	Factory Default Settings
Authority	Administrator
Admin	Admin
Password	Admin
Note: Since firmware version V3.11 (or later), the default username and password are not supported. Users need to create them for their initial login.	

Accessible IP Settings

IP Filter Settings

Item	Factory Default Settings
Enable the IP filter table	Empty, there is no limit to allowing any outgoing access.
Activate	
From (IP Address)	
To (IP Address)	

(B.3) Factory Default Settings for “Web HMI” Menu Option

The tables below outline the factory default settings for the items listed in the “Web HMI” menu.

Web HMI

Factory Default Settings
Depends on the Modbus setting function of the ET-7x00/PET-7x00.

Web Edit

Factory Default Settings
Main Page

(B.4) Factory Default Settings for the “Pair Connection” Menu Option

The table below outlines the factory default settings for the “Pair Connection” option.

Pair Connection

Configuration of Communication

Item	Factory Default Settings
Connection Timeout (ms)	2000
Reconnect Interval (ms)	3000

Remote DI to Local DO

Item	Factory Default Settings
Communication Timeout (ms)	1000
Scan Time (ms)	1000
Local DO Base Address	0
I/O Count	0
IP Address of the Remote Device	192.168.255.200
Modbus TCP Port	502
Modbus ID	1
Remote DI Base Address	0

Local DI to Remote DO

Item	Factory Default Settings
Communication Timeout (ms)	1000
Scan Time (ms)	1000
Local DI Base Address	0
I/O Count	0
IP Address of the Remote Device	192.168.255.200
Modbus TCP Port	502
Modbus ID	1
Remote DO Base Address	0

3.2.3. Module I/O Settings

After completing the general configuration of the ET-7x00/PET-7x00 module described in the previous section, the settings for the input and output channels need to be configured, such as the channel range and the alarm, etc.

Modbus Address	Function	Value	Options
00226	Reset to Factory Default Settings	<input type="checkbox"/>	
00233	Reboot ET-7000/PET-7000	<input type="checkbox"/>	
40555	Reset Status	1	1:Power-on, 2:Module Watchdog, 3:Reset command
40556	Reset Event Counter	21	
40557	Host Watchdog Timeout	0	0:Disabled, 1~65535:Enabled (units:0.1 seconds)
40558	WDT Event Counter	0	

Modbus Address	Function	Value	Options
40271	Modbus Unit ID	1	0~255 (default:1)

Tips & Warnings



The contents displayed on this page will be depending on the Modbus functions applicable to the specific ET-7x00/PET-7x00 module. Please refer to the user manual for each module for details on how to configure the relevant I/O settings.

In this example, ET-7026/PET-7026 will be used to explain the I/O settings. (The ET-7026/PET-7026 is a multi-function module that has 6 AI channels, 2 AO channels, 2 DI channels and 2 DO channels.)

(A) Common Functions

The **Common Functions** area provides options that allow the settings for the Modbus functions to be configured.

Common Functions			
Modbus Address	Function		
00226	Reset to Factory Default Settings	<input type="checkbox"/>	
00233	Reboot ET-7000/PET-7000	<input type="checkbox"/>	
40555	Reset Status	<input type="text" value="1"/>	1:Power-on, 2:Module Watchdog, 3:Reset command
40556	Reset Event Counter	<input type="text" value="21"/>	
40557	Host Watchdog Timeout	<input type="text" value="0"/>	0:Disabled, 1~65535:Enabled (units:0.1 seconds)
40558	WDT Event Counter	<input type="text" value="0"/>	

Modbus Definition			
Modbus Address	Function		
40271	Modbus Unit ID	<input type="text" value="1"/>	0~255 (default:1)

(B) Digital Output Settings

The **Digital Output settings** area provides details of the configuration settings for all digital output channels.

Channel	Power-on Value	Safe Value	Dropdown
Ch0	<input type="radio"/> On <input checked="" type="radio"/> Off	<input type="radio"/> On <input checked="" type="radio"/> Off	Disabled - Maintain the current status
Ch1	<input type="radio"/> On <input checked="" type="radio"/> Off	<input type="radio"/> On <input checked="" type="radio"/> Off	Disabled - Maintain the current status

Power-on value:

Used to preset the power-on value of the DO.

Safe Value

When choosing the “Disabled – Maintain the current status” option

Whether the Host Watchdog or Pair-Connection feature is enabled, the Safe Value will not take effect (the DO remains in its original state).

When choosing the “Enabled – Host Watchdog” option

Remember to set a Host Watchdog timeout in the “Common Functions” section. Notice that the Host Watchdog will be enabled by entering a non-zero value.

40557	Host Watchdog Timeout	100	0:Disabled, 1~65535:Enabled (units:0.1 seconds)
-------	-----------------------	-----	---

If the Host Watchdog is enabled, the digital outputs will be set to the safe value when the communication between a Host PC and the ET-7x00/ PET-7x00 module is interrupted. In this case, the timeout is set to 10 seconds.

When choosing the “Enabled – Pair-Connection” option

Make sure that the Pair Connection function has been configured, refer to Section 3.5. If the communication between the module and the remote module is failed, the digital outputs will be set to the safe value.

Refer to “Appendix A. Description of I/O Functions” for more information.

(C) Digital Input Settings

All digital input channels in ET-7x00/PET-7x00 modules can be used as 32-bit counters and each counter consists of two address values, the Low word, and the High word. Specific individual DI channels can be counted via the Digital Input settings web page.

Digital Input Settings

Modbus Address	Function	
00350	Enable DI Latched Status	<input type="radio"/> Enable <input checked="" type="radio"/> Disable

Channel	Digital Input Counter	Preset Value for Digital Input Counter
Ch0	<input type="radio"/> Enable <input checked="" type="radio"/> Disable	<input type="text" value="0"/> 0~4294967294
Ch1	<input type="radio"/> Enable <input checked="" type="radio"/> Disable	<input type="text" value="0"/> 0~4294967294

- **Enable DI Latched Status:**

When the DI Latch function is enabled, once the digital input channel detects any change in input status, the input status will be latched until it is cleared by using the clear command manually.

- **Digital Input Counter:**

When the Counter mode is selected, one counter will record the number of pulses from the digital signal for the selected channel, and will then record the count value in the register.

- **Preset Value for Digital Input Counter:**

This option allows the default values for the counters to be set.

Tips

When the signal occurs for a short time, the Host (Modbus TCP master) may not be in a hurry to read the changed state of DI, and will mistakenly think that DI has not changed all the time.

In this case, you can read the state of the DI Latch or DI Input Counter to determine whether DI has ever changed.

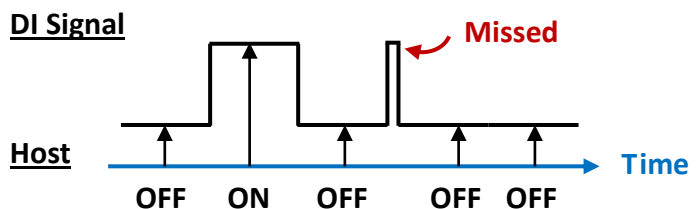

(D) DI Low-Pass Filter

Modbus Address	Function	Settings
00349	Counter Value Inverse	<input checked="" type="radio"/> Disable <input type="radio"/> Enable
<input type="button" value="SUBMIT"/>		
Modbus Address	Function	Settings
40100	Low-Pass Filter	Disable
40101	Pulse Width Filtering (Signal pulses below this width are ignored)	<input type="text" value="2"/> 2 ~ 250 (units: ms)
<input type="button" value="SUBMIT"/>		

- Disable
- 2 Hz, Min. Pulse Width is 250 ms
- 10 Hz, Min. Pulse Width is 50 ms
- 20 Hz, Min. Pulse Width is 25 ms
- 50 Hz, Min. Pulse Width is 10 ms
- 100 Hz, Min. Pulse Width is 5 ms
- 250 Hz, Min. Pulse Width is 2 ms
- User-defined minimum pulse width

- **Low-Pass Filter**

Preventing Signal Bounce

When mechanical switches or sensors change state, they can sometimes create "bouncy" signals, which means the signal quickly turns on and off many times. The low-pass filter cleans up these bouncy signals, making the DI input stable and preventing mistakes

(E) Analog Output Settings

The **Analog Output settings** section contains the Range, Slew Rate, Power-on Value, and Safe Values Settings that will be described in detail below.

The screenshot displays the 'Analog Output Settings' interface. It is divided into two main sections. The top section is titled 'Range' and 'Slew Rate'. It has two rows for channels Ch0 and Ch1. For Ch0, the Range is set to '32, 0 ~ 10 V' and the Slew Rate is '00, Immediate'. For Ch1, the Range is also '32, 0 ~ 10 V' and the Slew Rate is '00, Immediate'. There is a checkbox labeled 'Apply the current settings to all channels' which is unchecked. A 'SUBMIT' button is located below these settings. The bottom section is titled 'Power-on Value' and 'Safe Value'. It also has two rows for Ch0 and Ch1. For Ch0, the Power-on Value is '0.0' and the Safe Value is '0.0', both with a range of '0 ~ 10 V'. For Ch1, the Power-on Value is '0.0' and the Safe Value is '0.0', both with a range of '0 ~ 10 V'. A dropdown menu for the Safe Value of Ch1 is open, showing options: 'Disabled - Maintain the current status', 'Enabled - Host Watchdog', and 'Enabled - Pair-Connection'. A 'SUBMIT' button is located below these settings.

- **Range:**

In a manner, a different range can be set for individual analog output channels. Select the required voltage/current range from the respective drop-down menus. For more detailed technical specifications related to the output range for each analog output channel, please refer to: "**Appendix C. Analog Output Type and Data Format Table**".

Tips & Warnings



For modules that support the Voltage/Current type (e.g., [ET-7017](#)) or the Voltage/Current/Thermocouple type (e.g., [ET-7018Z/S](#)), the jumper is at the [Voltage/Thermocouple] position by default. To use the Current signal, you need to adjust the jumper(s).

Before selecting the range for each AIO channel, make sure that jumpers are set properly. For more detailed related to the jumper settings for each ET-7x00/PET-7x00 module, please refer to "[ET7000 ET7200 Register Table](#)".

ICP DAS | Ethernet I/O Modules

Voltage/Current Input Selection Jumper

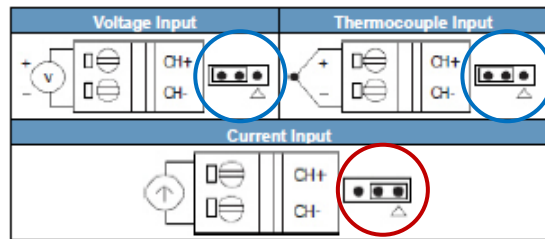

Remove the top case of the module

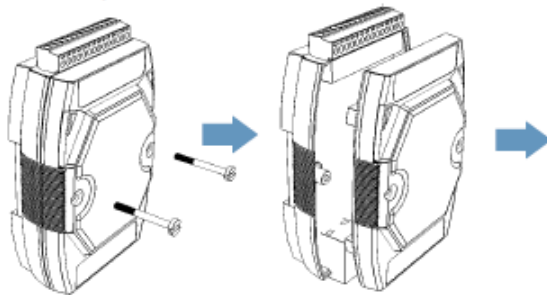

Wire Connections

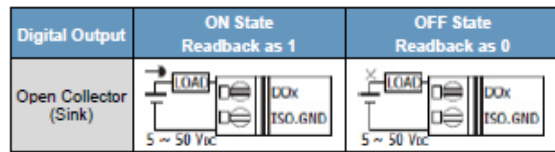

The selection jumpers are next to the connector

Channel	CH0±	CH1±	CH2±	CH3±	CH4±	CH 5±	CH 6±	CH 7±	CH 8±	CH 9±
Jumper	J1	J2	J3	J4	J5	J6	J7	J8	J9	J10

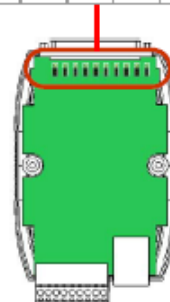

- **Slew Rate:**

This is the programmable output slew rate for the analog output channels, i.e., the rate of change in the analog output voltage/current as it changes from one output voltage/current to another. Select the most appropriate value from the respective drop-down menus.

- **Power-on Value:**

A power-on value can be set for a specific analog output channel. After rebooting the module, the analog output value will be set to the power-on value.

- **Safe Value:**

The Host Watchdog can be enabled or disabled by configuring the Host Watchdog Timeout setting in the (A) "Common Functions" section. When communication between the Host PC and the ET-7x00/PET-7x00 module is interrupted, the analog output value will be set to a predefined safe value.

For a more detailed description of these Modbus functions, please refer to "Appendix C. Modbus Application Notes".

(F) Analog Input Settings

The **Analog Input Settings** area contains two parts, the Range settings, and Modbus function Settings, which will be described in detail below.

Analog Input Settings

Channel		Range	
Ch0	<input checked="" type="radio"/> Enable <input type="radio"/> Disable	08, -10 ~ 10 V	<input type="checkbox"/> Apply the current settings to all channels
Ch1	<input checked="" type="radio"/> Enable <input type="radio"/> Disable	08, -10 ~ 10 V	
Ch2	<input checked="" type="radio"/> Enable <input type="radio"/> Disable	08, -10 ~ 10 V	
Ch3	<input checked="" type="radio"/> Enable <input type="radio"/> Disable	08, -10 ~ 10 V	
Ch4	<input checked="" type="radio"/> Enable <input type="radio"/> Disable	08, -10 ~ 10 V	
Ch5	<input checked="" type="radio"/> Enable <input type="radio"/> Disable	08, -10 ~ 10 V	

Modbus Address	Function	
00628	Normal Mode (10 Hz)/Fast Mode (50 Hz)	<input checked="" type="radio"/> Normal mode <input type="radio"/> Fast mode
00629	60/50 Hz Rejection	<input checked="" type="radio"/> 60 Hz <input type="radio"/> 50 Hz
00631	Data Format	<input checked="" type="radio"/> HEX 2's complement <input type="radio"/> Engineering
00632	Restore Analog Calibration to Factory Settings	<input type="checkbox"/>

Modbus Address	Function	
40654	Open Wire Detection	<input type="text" value="If the measured value is below 4 mA, it defaults to a value of -32768"/> <i>This feature is available only when the module is operating in the 4~20 mA current input mode and the data format is in engineering units.</i>

- **Enable/Disable:**

This section allows the user to enable or disable each analog input channel. For the ET-7000/ET-7200 series module, all analog input channels share a single A/D Chip so the user can

disable unused channels to improve the sampling rate for each channel. For example, the sampling rate for a total of eight AI channels of an ET-7017 is 10 Hz. If all channels are enabled, the sampling rate for each channel is 1.25 Hz. If three channels are disabled, the sampling rate for the enabled five channels is 2 Hz.

- **Range:**

ET-7x00/PET-7x00 modules provide a programmable input voltage/current range on all analog input channels, where a different range can be set for each analog input channel. Select the required voltage/current range from the respective drop-down menus. For more detailed technical specifications related to the input range for each analog input channel, please refer to: “Appendix B. Analog Input Type and Data Format Table”.

Tips & Warnings

For modules that support the Voltage/Current type (e.g., [ET-7017](#)) or the Voltage/Current/Thermocouple type (e.g., [ET-7018Z/S](#)), the jumper is at the [Voltage/Thermocouple] position by default. To use the Current signal, you need to adjust the jumper(s).

Before selecting the range for each AIO channel, make sure that jumpers are set properly. For more detailed related to the jumper settings for each ET-7x00/PET-7x00 module, please refer to “[ET7000 ET7200 Register Table](#)”.

ET-7019Z/PET-7019Z/ET-7219Z/PET-7219Z

ICP DAS | Ethernet I/O Modules

Voltage/Current Input Selection Jumper

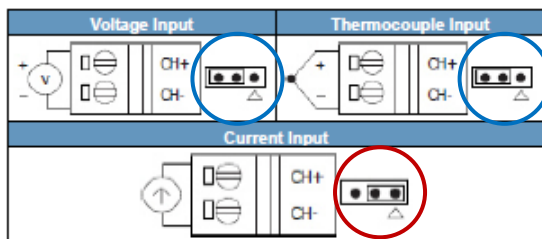

Remove the top case of the module

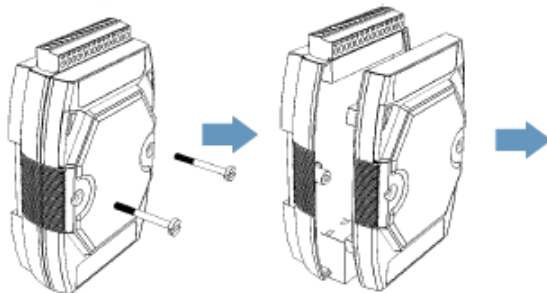

Wire Connections

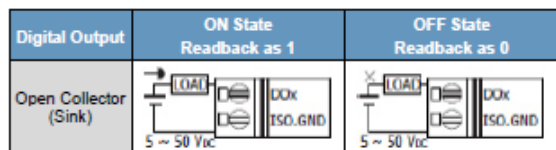

The selection jumpers are next to the connector

Channel	CH0±	CH1±	CH2±	CH3±	CH4±	CH 5±	CH 6±	CH 7±	CH 8±	CH 9±
Jumper	J1	J2	J3	J4	J5	J6	J7	J8	J9	J10

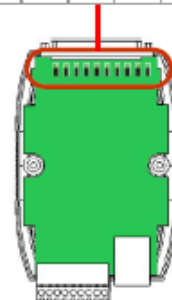

- **Normal Mode/Fast Mode:**

ET-7x00/PET-7x00 modules support sample rates in either “Normal” or “Fast” mode. The fast mode uses 60 Hz with a 16-bit resolution, while the Normal mode uses 10 Hz with a 16-bit resolution.

- **60/50 Hz Rejection:**

To remove the noise from the power supply, ET-7x00/PET-7x00 analog input modules feature two built-in rejection filters, that operate at different frequencies, 50 or 60 Hz, that are designed to remove noise generated by different power supplies.

- **Data Format:**

The analog value can be displayed in either hexadecimal or engineering.

Hexadecimal format:

All ranges of the Modbus 16-bit Register can be applied, where no resolution loss for the A/D or D/A value.

Engineering format:

Converting values is simple in this way, but there is some resolution loss when using the entire range of the Modbus 16-bit Register to express the value.

For example,

The input range of the ET-7017 is set to +/-10V,

08	-10 ~ +10 V	Engineering Unit	+10000	-10000
		2's comp HEX	7FFF	8000

If the real value is +6 V, the Modbus data will be:

Value in Hexadecimal: $6/10 * 0x7FFF = 0.6 * 32767 = 19660$ (or 0x4CCC)

Each scale is $10 \text{ V} / 32767 = 0.305 \text{ mV}$

Value in Engineering: $6/10 * 10000 = 6000$ (or 0x1770)

Each scale is $10 \text{ V} / 32767 = 1 \text{ mV}$

2's comp HEX

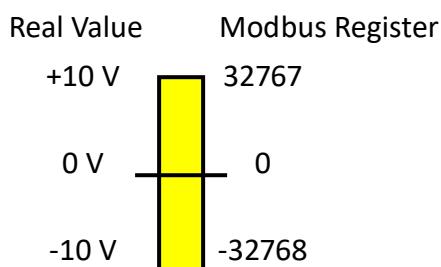

Engineering Unit

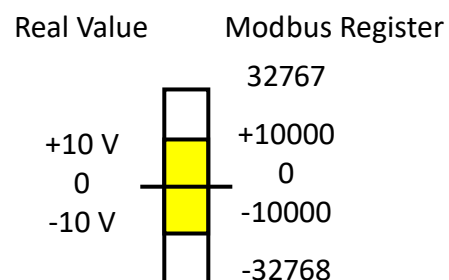

(G) NTC Thermistor Temperature Settings (for ET-7005) – User Defined Type

(P)ET-7005 supports NTC Thermistors, and the resistance/temperature characteristics of each manufacturer's Thermistor may vary. Although the (P)ET-7005 already supports several well-known brand of thermistors, it provides users with the function to create their own conversion formulas to match other thermistor.

The equipment listed below is used in this example.

1. ET-7005 * 1:

<https://www.icpdas.com/en/product/ET-7005>

The ET-7005 is a Ethernet I/O module with 8-ch Thermistor input and 4-ch DO. With a maximum resistance measurement of 200K ohms, the ET-7005 is capable of supporting temperatures as low as -40°C.

2. CA-TM-P100-L050 *1:

<https://www.icpdas.com/en/product/ET-7005#Accessories>

NTC Thermistor, Epoxy Resin Cable, 5M (-40 °C to +80 °C)



Step1: In the **Analog Input Settings** section, enable the channel you want to use (e.g., Ch0), set the **Range** to “ **71, User- Defined, -50 ~ 150°C**”, and click the **SUBMIT** button.

Channel	Enable	Disable	Range
Ch0	<input checked="" type="radio"/>	<input type="radio"/>	71, User-defined, -50 ~ 150 °C
Ch1	<input checked="" type="radio"/>	<input type="radio"/>	60, PreCon Type III 10K@25°C, -30 ~ 240 °F
Ch2	<input checked="" type="radio"/>	<input type="radio"/>	61, Fenwell Type U 2K@25°C, -50 ~ 150 °C
Ch3	<input checked="" type="radio"/>	<input type="radio"/>	62, Fenwell Type U 2K@25°C, 0 ~ 150 °C
Ch4	<input checked="" type="radio"/>	<input type="radio"/>	63, YSI L Mix 100@25°C, -80 ~ 100 °C
Ch5	<input checked="" type="radio"/>	<input type="radio"/>	64, YSI L Mix 300@25°C, -80 ~ 100 °C
Ch6	<input checked="" type="radio"/>	<input type="radio"/>	65, YSI L Mix 1000@25°C, -70 ~ 100 °C
Ch7	<input checked="" type="radio"/>	<input type="radio"/>	66, YSI B Mix 2252@25°C, -50 ~ 150 °C
			67, YSI B Mix 3000@25°C, -40 ~ 150 °C
			68, YSI B Mix 5000@25°C, -40 ~ 150 °C
			69, YSI B Mix 6000@25°C, -30 ~ 150 °C
			6A, YSI B Mix 10000@25°C, -30 ~ 150 °C
			6B, YSI H Mix 10000@25°C, -30 ~ 150 °C
			6C, YSI H Mix 30000@25°C, -10 ~ 200 °C
			70, User-defined, -50 ~ 150 °C
			71, User-defined, -50 ~ 150 °C
			72, User-defined, -50 ~ 150 °C
			73, User-defined, -50 ~ 150 °C
			74, User-defined, -50 ~ 150 °C
			75, User-defined, -50 ~ 150 °C
			76, User-defined, -50 ~ 150 °C

Step2: Users can refer to the thermistor's resistance-temperature table and enter three resistance values and their corresponding temperatures into the **User-Defined Type-71** item. It is recommended to follow the rules for optimal accuracy.

- (1) $-40^{\circ}\text{C} \leq T_1, T_2, T_3 \leq 150^{\circ}\text{C}$ (2) $|T_2 - T_1| \leq 50^{\circ}\text{C}$ (3) $|T_3 - T_2| \leq 50^{\circ}\text{C}$

Resistance (ohm)	Temperature (°C)
67770	-20
12090	20
3020	60

5.1 Tabella valori temperatura resistenza sensore NTC 10K@25°C β 3435

Temp. °C	Valore di Resistenza			Temp. °C	Valore di Resistenza			Temp. °C	Valore di Resistenza		
	Max. KΩ	Tipico KΩ	Min. KΩ		Max. KΩ	Tipico KΩ	Min. KΩ		Max. KΩ	Tipico KΩ	Min. KΩ
-50	344,60	329,50	314,90	1	26,65	26,13	25,62	56	3,50	3,43	3,35
-49	325,00	310,90	297,30	2	25,52	25,03	24,55	57	3,39	3,32	3,25
-48	306,60	293,50	280,90	3	24,44	23,99	23,54	58	3,28	3,22	3,15
-47	289,40	277,20	265,40	4	23,42	23,00	22,57	59	3,18	3,12	3,05
-46	273,40	262,00	251,00	5	22,45	22,05	21,66	60	3,09	3,02	2,95
-45	258,30	247,70	237,40	6	21,53	21,15	20,78	61	2,99	2,93	2,86
-44	244,20	234,30	224,70	7	20,64	20,30	19,95	62	2,90	2,84	2,77
-43	231,00	221,70	212,80	8	19,81	19,48	19,15	63	2,82	2,75	2,69
-42	218,60	209,90	201,60	9	19,01	18,70	18,39	64	2,73	2,67	2,61
-41	207,00	198,90	191,00	10	18,25	17,96	17,67	65	2,65	2,59	2,53
-40	196,00	188,50	181,10	11	17,51	17,24	16,97	66	2,57	2,51	2,45
-39	185,50	178,50	171,60	12	16,81	16,56	16,30	67	2,50	2,44	2,38
-38	175,60	169,00	162,60	13	16,14	15,90	15,67	68	2,42	2,36	2,31
-37	166,30	160,20	154,20	14	15,50	15,28	15,06	69	2,35	2,30	2,24
-36	157,60	151,90	146,30	15	14,89	14,69	14,48	70	2,28	2,23	2,17
-35	149,40	144,10	138,80	16	14,31	14,12	13,92	71	2,22	2,16	2,11
-34	141,70	136,70	131,80	17	13,75	13,58	13,39	72	2,15	2,10	2,05
-33	134,50	129,80	125,20	18	13,22	13,06	12,89	73	2,09	2,04	1,99
-32	127,70	123,30	119,00	19	12,72	12,56	12,40	74	2,03	1,98	1,93
-31	121,20	117,10	113,10	20	12,24	12,09	11,94	75	1,98	1,92	1,87
-30	115,20	111,30	107,50	21	11,77	11,63	11,50	76	1,92	1,87	1,82
-29	109,40	105,70	102,20	22	11,32	11,20	11,07	77	1,87	1,82	1,77
-28	103,90	100,50	97,20	23	10,90	10,78	10,66	78	1,81	1,77	1,72
-27	98,68	95,52	92,45	24	10,49	10,38	10,27	79	1,76	1,72	1,67
-26	93,80	90,84	87,97	25	10,10	10,00	9,90	80	1,72	1,67	1,62
-25	89,20	86,43	83,73	26	9,73	9,63	9,53	81	1,67	1,62	1,58
-24	84,85	82,26	79,74	27	9,38	9,28	9,18	82	1,62	1,58	1,53
-23	80,76	78,33	75,96	28	9,04	8,94	8,84	83	1,58	1,53	1,49
-22	76,89	74,61	72,39	29	8,72	8,62	8,52	84	1,54	1,49	1,45
-21	73,23	71,10	69,01	30	8,41	8,31	8,21	85	1,49	1,45	1,41
-20	69,77	67,77	65,82	31	8,11	8,01	7,92	86	1,45	1,41	1,37
-19	66,44	64,57	62,74	32	7,83	7,73	7,63	87	1,42	1,37	1,33
-18	63,30	61,54	59,83	33	7,55	7,45	7,36	88	1,38	1,34	1,30
-17	60,32	58,68	57,07	34	7,29	7,19	7,10	89	1,34	1,30	1,26
-16	57,51	55,97	54,46	35	7,04	6,94	6,85	90	1,31	1,27	1,23
-15	54,85	53,41	51,99	36	6,79	6,70	6,61	91	1,27	1,23	1,19
-14	52,33	50,98	49,65	37	6,56	6,47	6,37	92	1,24	1,20	1,16
-13	49,95	48,68	47,43	38	6,34	6,25	6,15	93	1,21	1,17	1,13
-12	47,69	46,50	45,32	39	6,12	6,03	5,94	94	1,17	1,14	1,10
-11	45,55	44,43	43,33	40	5,92	5,83	5,74	95	1,14	1,11	1,07
-10	43,52	42,47	41,43	41	5,72	5,63	5,54	96	1,12	1,08	1,04
-9	41,55	40,57	39,60	42	5,53	5,44	5,35	97	1,09	1,05	1,02
-8	39,69	38,77	37,86	43	5,34	5,26	5,17	98	1,06	1,02	0,99
-7	37,92	37,06	36,21	44	5,17	5,08	4,99	99	1,03	1,00	0,97
-6	36,25	35,44	34,64	45	5,00	4,91	4,83	100	1,01	0,97	0,94
-5	34,66	33,90	33,15	46	4,83	4,75	4,67	101	0,98	0,95	0,92
-4	33,15	32,44	31,73	47	4,68	4,59	4,51	102	0,96	0,92	0,89
-3	31,72	31,05	30,39	48	4,52	4,44	4,36	103	0,93	0,90	0,87
-2	30,36	29,73	29,11	49	4,38	4,30	4,22	104	0,91	0,88	0,85
-1	29,06	28,48	27,89	50	4,24	4,16	4,08	105	0,89	0,86	0,83
0	27,83	27,28	26,74	51	4,10	4,03	3,95	106	0,87	0,84	0,81
				52	3,97	3,90	3,82	107	0,84	0,82	0,79
				53	3,85	3,77	3,70	108	0,82	0,80	0,77
				54	3,73	3,65	3,58	109	0,80	0,78	0,75
				55	3,61	3,54	3,46	110	0,79	0,76	0,73

Step3: Once the **Calculate** button is clicked, the Steinhart coefficient will be computed. Then, click the **Save** button to save the settings and finalize the configuration.

Thermistor Steinhart-Hart Coefficients

Step 1: Input temperatures and resistance for basis of calculating A, B and C.
 Step 2: Click the Calculate button to calculate coefficients.
 Step 3: Click the Save button to save the coefficients.

User-defined Type	Low Temperature Parameters	Mid Temperature Parameters	High Temperature Parameters	Coefficients	
70	<input type="text"/> ohms <input type="text"/> °C	<input type="text"/> ohms <input type="text"/> °C	<input type="text"/> ohms <input type="text"/> °C	A <input type="text"/> 3CB34A92 B <input type="text"/> BB58DE17 C <input type="text"/> 375C405F	<input type="button" value="CALCULATE"/> <input type="button" value="SAVE"/>
71	<input type="text" value="67770"/> ohms <input type="text" value="-20"/> °C	<input type="text" value="12090"/> ohms <input type="text" value="20"/> °C	<input type="text" value="3020"/> ohms <input type="text" value="60"/> °C	A <input type="text" value="0.0008931457241"/> 3A6A21FF B <input type="text" value="0.0002505307333"/> 398359AA C <input type="text" value="1.9630498418100"/> 3452C7E7	<input type="button" value="CALCULATE"/> <input type="button" value="SAVE"/>
72	<input type="text"/> ohms <input type="text"/> °C	<input type="text"/> ohms <input type="text"/> °C	<input type="text"/> ohms <input type="text"/> °C	A <input type="text"/> 00000000 B <input type="text"/> 00000000 C <input type="text"/> 00000000	<input type="button" value="CALCULATE"/> <input type="button" value="SAVE"/>

71	<input type="text"/> ohms <input type="text"/> °C	<input type="text"/> ohms <input type="text"/> °C	<input type="text"/> ohms <input type="text"/> °C	A <input type="text" value="3A6A21FF"/> 3A6A21FF B <input type="text" value="398359AA"/> 398359AA C <input type="text" value="3452C7E7"/> 3452C7E7	<input type="button" value="CALCULATE"/> <input type="button" value="SAVE"/>
72	<input type="text"/> ohms <input type="text"/> °C	<input type="text"/> ohms <input type="text"/> °C	<input type="text"/> ohms <input type="text"/> °C	A <input type="text"/> 00000000 B <input type="text"/> 00000000 C <input type="text"/> 00000000	<input type="button" value="CALCULATE"/> <input type="button" value="SAVE"/>

Step4: The user can view the current temperature of the AI0 on the **Web HMI** page.

Overview THIS COMPUTER - - ET-7000

Configuration -

- Network Settings
- Basic Settings
- Module I/O Settings

Authentication +

Web HMI -

- Web HMI
- Web Edit

Pair Connection

More Information

Analog Inputs

Channel No.	Actual Value	Historical Max/Min Value		High/Low Alarm	
AI0	-9.33 °C <small>Modbus: 30000: FC5B</small>	Max: -9.07 °C <small>Modbus: 30236: FC75</small>	Min: -9.33 °C <small>Modbus: 30268: FC5B</small>	High Alarm: OFF <small>Modbus: 10224: 0</small>	Low Alarm: OFF <small>Modbus: 10256: 0</small>
AI1	0.0 °C <small>Modbus: 30001: 0000</small>	Max: 0.0 °C <small>Modbus: 30237: 0000</small>	Min: 0.0 °C <small>Modbus: 30269: 0000</small>	High Alarm: OFF <small>Modbus: 10225: 0</small>	Low Alarm: OFF <small>Modbus: 10257: 0</small>
AI2	0.0 °C <small>Modbus: 30002: 0000</small>	Max: 0.0 °C <small>Modbus: 30238: 0000</small>	Min: 0.0 °C <small>Modbus: 30270: 0000</small>	High Alarm: OFF <small>Modbus: 10226: 0</small>	Low Alarm: OFF <small>Modbus: 10258: 0</small>
AI3	0.0 °C <small>Modbus: 30003: 0000</small>	Max: 0.0 °C <small>Modbus: 30239: 0000</small>	Min: 0.0 °C <small>Modbus: 30271: 0000</small>	High Alarm: OFF <small>Modbus: 10227: 0</small>	Low Alarm: OFF <small>Modbus: 10259: 0</small>
AI4	0.0 °C <small>Modbus: 30004: 0000</small>	Max: 0.0 °C <small>Modbus: 30240: 0000</small>	Min: 0.0 °C <small>Modbus: 30272: 0000</small>	High Alarm: OFF <small>Modbus: 10228: 0</small>	Low Alarm: OFF <small>Modbus: 10260: 0</small>
AI5	0.0 °C <small>Modbus: 30005: 0000</small>	Max: 0.0 °C <small>Modbus: 30241: 0000</small>	Min: 0.0 °C <small>Modbus: 30273: 0000</small>	High Alarm: OFF <small>Modbus: 10229: 0</small>	Low Alarm: OFF <small>Modbus: 10261: 0</small>
AI6	0.0 °C <small>Modbus: 30006: 0000</small>	Max: 0.0 °C <small>Modbus: 30242: 0000</small>	Min: 0.0 °C <small>Modbus: 30274: 0000</small>	High Alarm: OFF <small>Modbus: 10230: 0</small>	Low Alarm: OFF <small>Modbus: 10262: 0</small>
AI7	0.0 °C <small>Modbus: 30007: 0000</small>	Max: 0.0 °C <small>Modbus: 30243: 0000</small>	Min: 0.0 °C <small>Modbus: 30275: 0000</small>	High Alarm: OFF <small>Modbus: 10231: 0</small>	Low Alarm: OFF <small>Modbus: 10263: 0</small>

RESET ALL MAX. VALUES RESET ALL MIN. VALUES

AI1 to AI7 are set to "Disable"

AI DO

Analog Inputs

Channel No.	Actual Value	Historical Max/Min Value		High/Low Alarm	
AI0	-9.33 °C <small>Modbus: 30000: FC5B</small>	Max: -9.07 °C <small>Modbus: 30236: FC75</small>	Min: -9.33 °C <small>Modbus: 30268: FC5B</small>	High Alarm: OFF <small>Modbus: 10224: 0</small>	Low Alarm: OFF <small>Modbus: 10256: 0</small>

(H) Alarm Settings

The ET-7x00/PET-7x00 modules feature a built-in alarm function. The alarm settings include two parts, the high limit value, and the low limit value, and each need to be configured for a specific channel.

Alarm Settings

Channel		High Limit Value		Mode	
Ch0	<input type="radio"/> Enable <input checked="" type="radio"/> Disable	<input type="text" value="10.0"/>	-10 ~ 10 V	Monetary	<input type="checkbox"/> Apply the current settings to all channels
Ch1	<input type="radio"/> Enable <input checked="" type="radio"/> Disable	<input type="text" value="10.0"/>	-10 ~ 10 V	Monetary	
Ch2	<input type="radio"/> Enable <input checked="" type="radio"/> Disable	<input type="text" value="10.0"/>	-10 ~ 10 V	Monetary	
Ch3	<input type="radio"/> Enable <input checked="" type="radio"/> Disable	<input type="text" value="10.0"/>	-10 ~ 10 V	Monetary	
Ch4	<input type="radio"/> Enable <input checked="" type="radio"/> Disable	<input type="text" value="10.0"/>	-10 ~ 10 V	Monetary	
Ch5	<input type="radio"/> Enable <input checked="" type="radio"/> Disable	<input type="text" value="10.0"/>	-10 ~ 10 V	Monetary	

- **Enable/Disable:**

This section allows each analog input alarm to be set to enable or disabled.

- **High/Low Limit Value:**

Both the high alarm value and the low alarm value can be defined in the High (or Low) Limit Value text box. When the analog input value is higher than the high alarm value, or lower than the low alarm value, an alarm occurs. The alarm status will then be activated and switched to on.

Channel		Low Limit Value		Mode	
Ch0	<input type="radio"/> Enable <input checked="" type="radio"/> Disable	<input type="text" value="-10.0"/>	-10 ~ 10 V	Monetary	<input type="checkbox"/> Apply the current settings to all channels
Ch1	<input type="radio"/> Enable <input checked="" type="radio"/> Disable	<input type="text" value="-10.0"/>	-10 ~ 10 V	Monetary	
Ch2	<input type="radio"/> Enable <input checked="" type="radio"/> Disable	<input type="text" value="-10.0"/>	-10 ~ 10 V	Monetary	
Ch3	<input type="radio"/> Enable <input checked="" type="radio"/> Disable	<input type="text" value="-10.0"/>	-10 ~ 10 V	Monetary	
Ch4	<input type="radio"/> Enable <input checked="" type="radio"/> Disable	<input type="text" value="-10.0"/>	-10 ~ 10 V	Monetary	
Ch5	<input type="radio"/> Enable <input checked="" type="radio"/> Disable	<input type="text" value="-10.0"/>	-10 ~ 10 V	Monetary	

- **Mode:**

The ET-7x00/PET-7x00 allows the alarm to be selected as either Momentary or Latch mode, which can be set using the Mode combo box for both the low alarm and the high alarm.

- **Latch Mode:**

An alarm will be triggered when the analog input value exceeds alarm limits. When the AI value is back to normal, the alarm status will keep until the clear command is sent to the specific address.

- **Momentary Mode:**

An alarm will be triggered when the analog input value exceeds alarm limits. When the AI value is back to normal, the alarm status will automatically be cleared.

3.3. Authentication

The “**Authentication**” menu contains the following options:

Overview	
Configuration	—
Network Settings	
Basic Settings	
Module I/O Settings	
Authentication	—
Account Management	
Accessible IP Settings	
Web HMI	—
Web HMI	
Web Edit	
Pair Connection	
Maintenance	—
Import / Export Configuration	
More Information	
Logout	

Privilege Management:

Provides access to the Privilege Management and Reset Settings sections. The user can manage user accounts and their associated privileges and also reset the settings.

Accessible IP Settings:

Provides access to the IP Filter Settings page, which allows you to control access to the web page.

3.3.1. Account Management

The **Privilege Management** page provides functions that allow the following tasks to be performed:

FW V30x

Privilege Management

No.	Account	Password	Confirm Password	Authority	Enabled
1	Admin	Admin ▾	<input checked="" type="checkbox"/>
2	<input type="text" value="user01"/>	User ▾	<input checked="" type="checkbox"/>
3	<input type="text" value="admin01"/>	Admin ▾	<input checked="" type="checkbox"/>
4	<input type="text"/>	<input type="text"/>	<input type="text"/>	Admin ▾	<input type="checkbox"/>
5	<input type="text"/>	<input type="text"/>	<input type="text"/>	Admin ▾	<input type="checkbox"/>

Reset Settings

Restore settings to the defaults

After clicking this button, all accounts will be removed and restore the default account.

FW V311

Privilege Management

Active	Role	Username	Password	
	administrator	<input type="text" value="Admin"/>	<input type="text" value="1111"/>	<input type="button" value="SAVE"/>
<input checked="" type="checkbox"/>	user ▾	<input type="text" value="user01"/>	<input type="text" value="abc@001"/>	<input type="button" value="SAVE"/>
<input checked="" type="checkbox"/>	administrator ▾	<input type="text" value="admin01"/>	<input type="text" value="admin01"/>	<input type="button" value="SAVE"/>
<input type="checkbox"/>	user ▾	<input type="text"/>	<input type="text"/>	<input type="button" value="SAVE"/>
<input type="checkbox"/>	user ▾	<input type="text"/>	<input type="text"/>	<input type="button" value="SAVE"/>

(A) Configuring the User Accounts

The ET-7x00/PET-7x00 interface supports a maximum of five user accounts, including:

- An Administrator Account
FW V3.0x (or older) provides a default administrator account (Admin). Since FW v3.11 (or later), the user needs to create an administrator account upon login, which must be at least 4 characters long. This account cannot be deleted, but administrators can change the username/password.
- Four User-defined Accounts
Each account consists of a username, a password, and an authority level. There are two types of authority levels: Administrator and User.
 - **Admin:**
With the highest authority, the administrator has full access to all functions on the ET-7x00/ PET-7x00 web page, including modifying or reviewing all settings.
 - **User:**
This level only allows the user to view some of the module settings. The user cannot modify any settings through the ET-7x00/PET-7x00 web page.

(B) Restoring the Factory Default User Accounts

The ET-7x00/PET-7x00 has a built-in administrator account (**Admin**) that can be modified but cannot be deleted. The firmware version 30x allows the user to restore the default settings (password: Admin) by clicking the “**Reset Settings**” button.

Note:

Firmware v3.11 (or later) does not include a default administrator account for security reasons. Also, there is no “**Reset Settings**” button on this page.

However, users can remove all usernames/passwords on the “**Basic Settings**” page and then create a new one the next time they log in. Alternatively, the ET-72xx/PET-72xx series have a physical **Reset** button that can be pressed and held for 5 seconds to restore the factory settings.

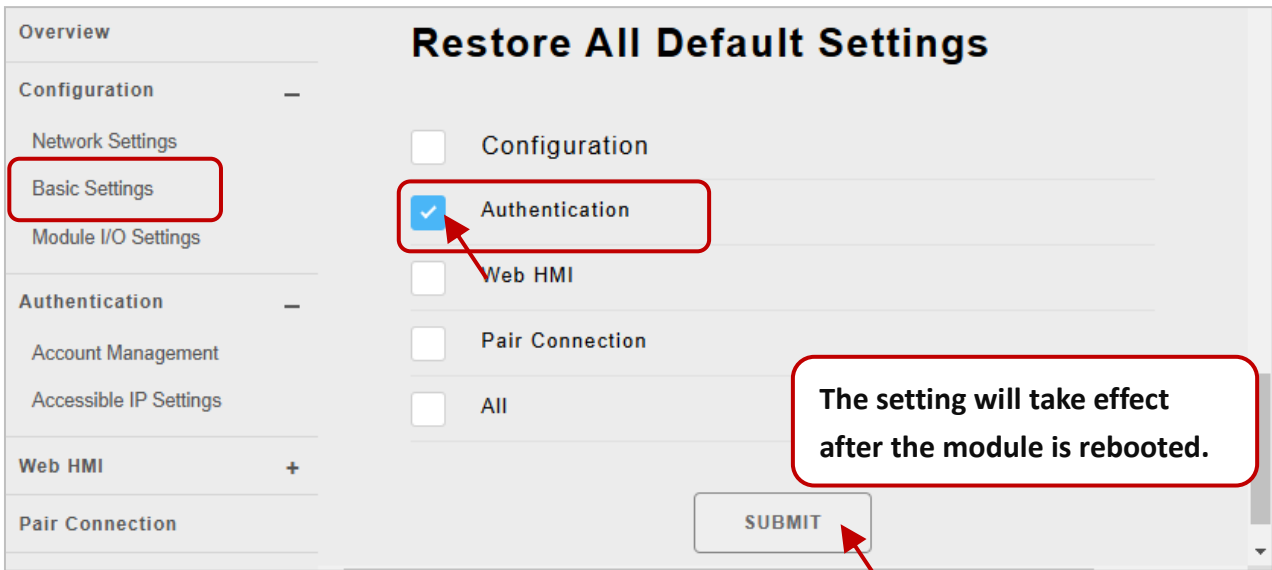

Press and hold the **Reset** button on the ET-7200/PET-7200 for 5 seconds to restore the factory settings.

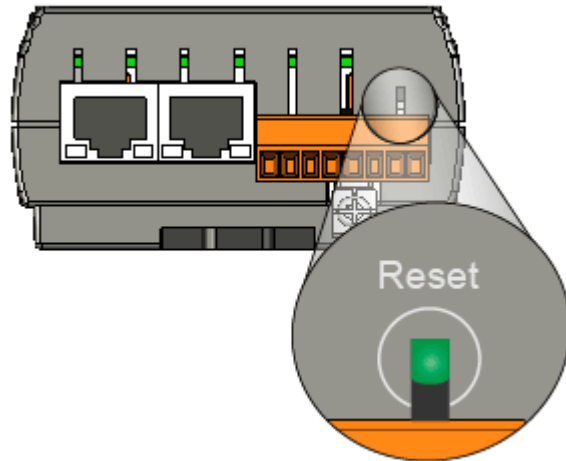

3.3.2. Accessible IP Settings

The **IP Filter Settings** page allows the user to whitelist a range of IP addresses. Only those in the list will have access to this module. **Note:** By default, there is no restriction on outgoing access.

IP Filter Settings

This feature allows you to whitelist a range of IP addresses. Only IP addresses in this list will be able to access this module.

IP address of the local computer is 192.168.79.33

Active	Start IP Address	End IP Address (Optional)	
<input checked="" type="checkbox"/>	192.168.79.201		SAVE
<input checked="" type="checkbox"/>	192.168.79.20	192.168.79.50	SAVE
<input checked="" type="checkbox"/>	192.168.79.10		SAVE
<input type="checkbox"/>			SAVE
<input type="checkbox"/>			SAVE
<input type="checkbox"/>			SAVE

✓ New settings are properly configured.

Follow the steps to configure the accessible IP addresses:

Step 1: Check the "**Active**" checkbox and input the Start and End IP addresses. Alternatively, users can only enter the Start IP address if you are not using continuous IP addresses.

Step 2: After making changes, click each "**SAVE**" button to save the settings.

Step 1: Reboot the module to apply the settings.

3.4. Web HMI

The “**Web HMI**” menu contains the following options:

Overview	
Configuration	—
Network Settings	
Basic Settings	
Module I/O Settings	
Authentication	—
Account Management	
Accessible IP Settings	
Web HMI	—
Web HMI	
Web Edit	
Pair Connection	
Maintenance	—
Import / Export Configuration	
More Information	
Logout	

Web HMI:

Provides access to the I/O monitor page, which allows you to remotely monitor and control the I/O status of the ET-7x00/PET-7x00 module.

Web Edit:

Provides access to the “Web Page Configuration” page, which allows you to create up to ten dynamic web HMI pages and set one of them as the start page so that it will be displayed when logging in to an ET-7000/ET-7200.

3.4.1. Web HMI

The ET-7x00/PET-7x00 module features a Web HMI web interface that can be used to display real-time I/O data values and alarms via the LAN or the Internet. Real-time I/O data values and alarms can be monitored at either the local or remote site using any web browser. Also, the Web HMI is completed immediately without requiring any programming skills (HTML or Java).

First, you can see the default I/O monitoring page (Main Page), which displays the supported I/O tabs for the module.

AI page

THIS COMPUTER - - ET-7000

AI AO DI DO

Analog Inputs

Channel No.	Actual Value	Historical Max/Min Value		High/Low Alarm	
AI0	0.0 V Modbus 30000: 0000	Max: 0.0 V Modbus 30236: 0001	Min: -0.0 V Modbus 30268: FFFF	High Alarm: OFF Modbus 10224: 0	Low Alarm: OFF Modbus 10256: 0
AI1	0.0 V Modbus 30001: 0000	Max: 0.0 V Modbus 30237: 0001	Min: -0.0 V Modbus 30269: FFFF	High Alarm: OFF Modbus 10225: 0	Low Alarm: OFF Modbus 10257: 0
AI2	0.0 V Modbus 30002: 0000	Max: -10.0 V Modbus 30238: D8F0	Min: 10.0 V Modbus 30270: 2710	High Alarm: OFF Modbus 10226: 0	Low Alarm: OFF Modbus 10258: 0
AI3	0.0 V Modbus 30003: 0000	Max: -10.0 V Modbus 30239: D8F0	Min: 10.0 V Modbus 30271: 2710	High Alarm: OFF Modbus 10227: 0	Low Alarm: OFF Modbus 10259: 0
AI4	0.0 V Modbus 30004: 0000	Max: -10.0 V Modbus 30240: D8F0	Min: 10.0 V Modbus 30272: 2710	High Alarm: OFF Modbus 10228: 0	Low Alarm: OFF Modbus 10260: 0
AI5	0.0 V Modbus 30005: 0000	Max: -10.0 V Modbus 30241: D8F0	Min: 10.0 V Modbus 30273: 2710	High Alarm: OFF Modbus 10229: 0	Low Alarm: OFF Modbus 10261: 0

RESET ALL MAX. VALUES RESET ALL MIN. VALUES

AO page

THIS COMPUTER -  - ET-7000

AIAODIDO

Analog Outputs

Channel No.	Actual Value	Output Value	Action
AO0	0.0 V <small>Modbus 40232: 0000</small>	<input style="width: 100px;" type="text"/> -10 ~ 10 V <small>Modbus 40000: 0000</small>	<input type="button" value="APPLY"/>
AO1	0.0 V <small>Modbus 40233: 0000</small>	<input style="width: 100px;" type="text"/> -10 ~ 10 V <small>Modbus 40001: 0000</small>	<input type="button" value="APPLY"/>

DI page

THIS COMPUTER -  - ET-7000

AIAODIDO

Digital Inputs

Channel No.	Modbus Register	Status	Counter	High Latched	Low Latched
DI0	10000	OFF	-	-	-
DI1	10001	OFF	-	-	-

DO page

THIS COMPUTER -  - ET-7000

AIAODIDO

Digital Outputs

Channel No.	Modbus Register	Status	Action
DO0	00000	OFF	<input type="button" value="OFF"/> <input type="button" value="ON"/>
DO1	00001	OFF	<input type="button" value="OFF"/> <input type="button" value="ON"/>

3.4.2. Web Edit

The ET-7x00/PET-7x00 module provides functions that enable users to create customized web pages. Users can upload specific I/O layout diagrams in either **.bmp**, **.jpg**, or **.gif** format and can define a description for each page.

By default, there is only a Main page, you can click the **“Add a new page”** button to add a page. Up to 10 user-defined web pages can be created.

Note: An asterisk indicates that the page is the start page.

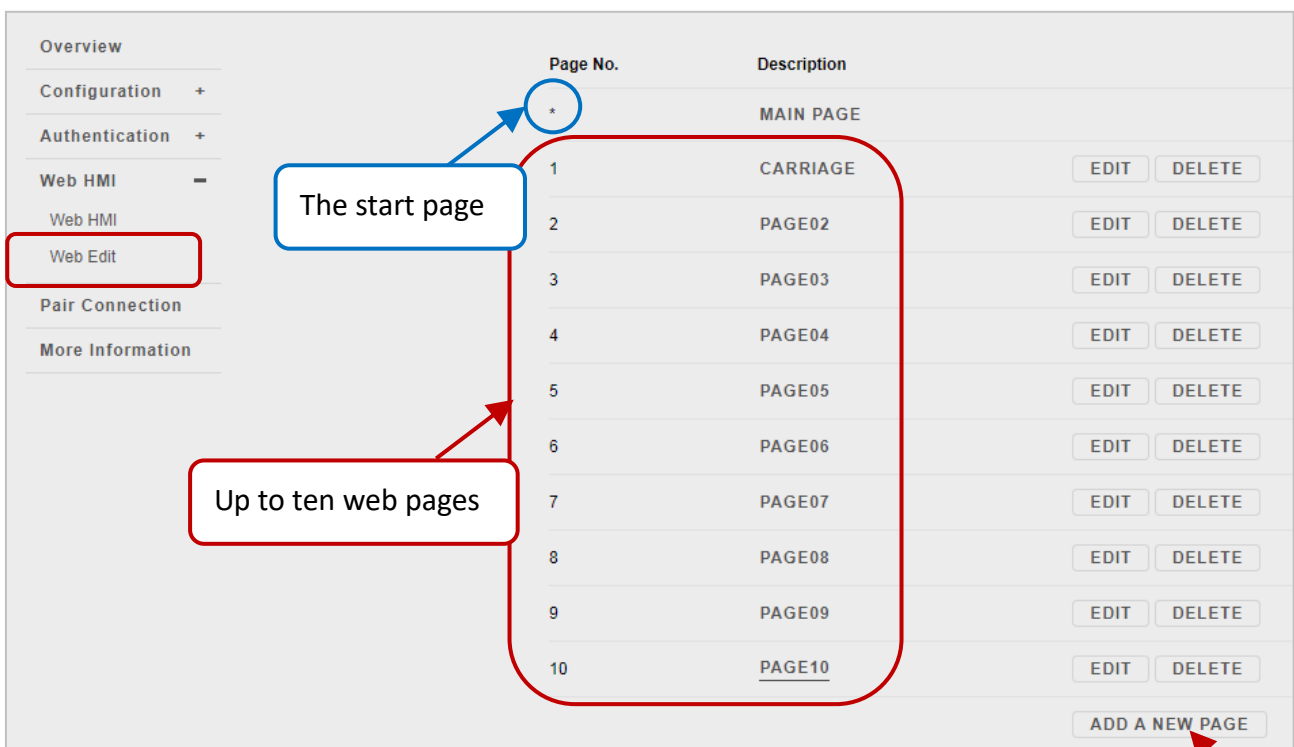

Next, you can also set the new page (e.g., Carriage) as a start page so that it will be displayed when logging in to an ET-7000/ET-7200. Click **“Yes”** under the **“Set as the Start Page”** section and click the **“SUBMIT”** button.

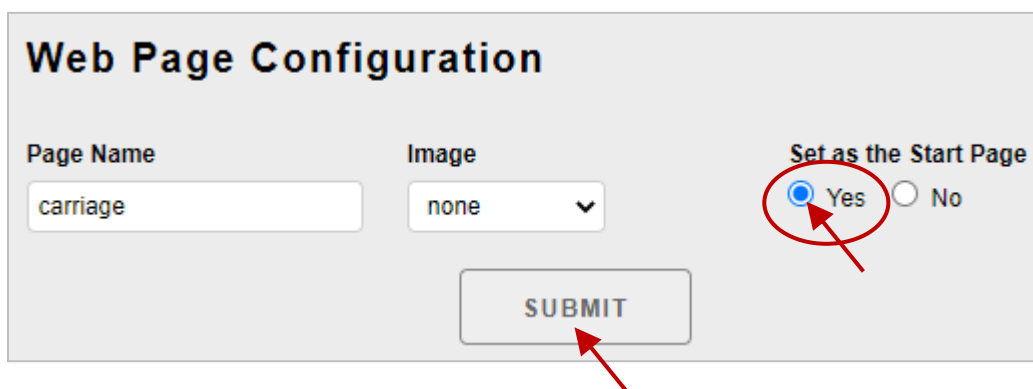

Click the “Web HMI” item to see the start pages (e.g., Carriage).

Channel No.	Alias	Status	Action
DI0	PHS1	OFF	
DO0	Motor	OFF	<input type="button" value="OFF"/> <input type="button" value="ON"/>

Below is an example of how to create a customized web page.

Example

Objective:

Create a Web page to monitor the I/O status of a conveyor system, as shown below. The I/O system contains a sensor that is used to detect the products and a switch that is used to turn the conveyor motor on and off.

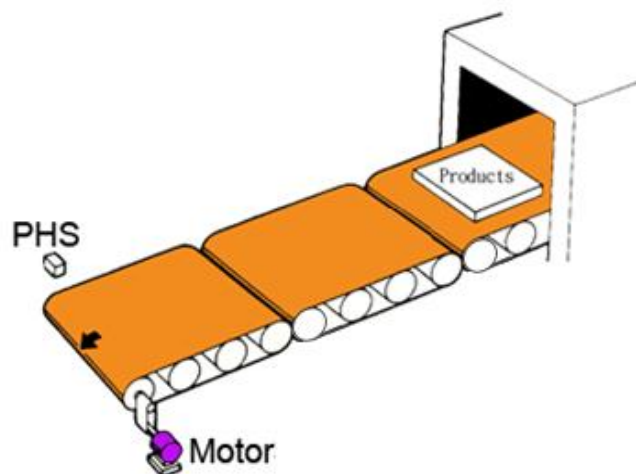

Step 1: Add a New Page

Click the “Add a new Page” button to begin creating a new page.

Web Page Configuration

Page No.	Description
*	MAIN PAGE

ADD A NEW PAGE

Step 2: Upload an Image

Click the “Choose File” button to select an image, and then click the “**UPLOAD**” button to upload the image to the ET-7x00/PET-7x00 module, as shown in the figure below.

Web Page Configuration

Page Name: Image: Set as the Start Page: Yes No

SUBMIT

DELETE ALL IMAGES **Choose File** **1.**

UPLOAD **2.**

The total space available for storing images is only 64Kb, so the file size for the image must be less than 64K bytes.

Tips & Warnings



The image can be in either **.jpg**, **.gif**, or **.bmp** format with a maximum file size of 64 KB. The recommended resolution for the image to be displayed on the editing Web page is 340 * 250 pixels.

After the upload is completed, you can see the image. Also, the file name will be added to the “Image” dropdown list box. (See the step3)

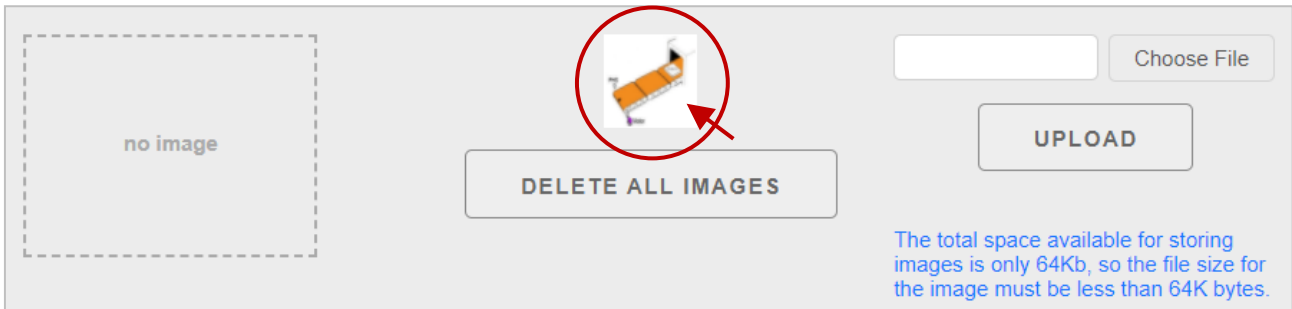

Step 3: Set the Page Name and Select the Image

Enter a name for the page in the “Page Name” field and then select an image from the “Image” dropdown list box. After selecting the image, it will be displayed in the preview window. Then, click the “SUBMIT” button.

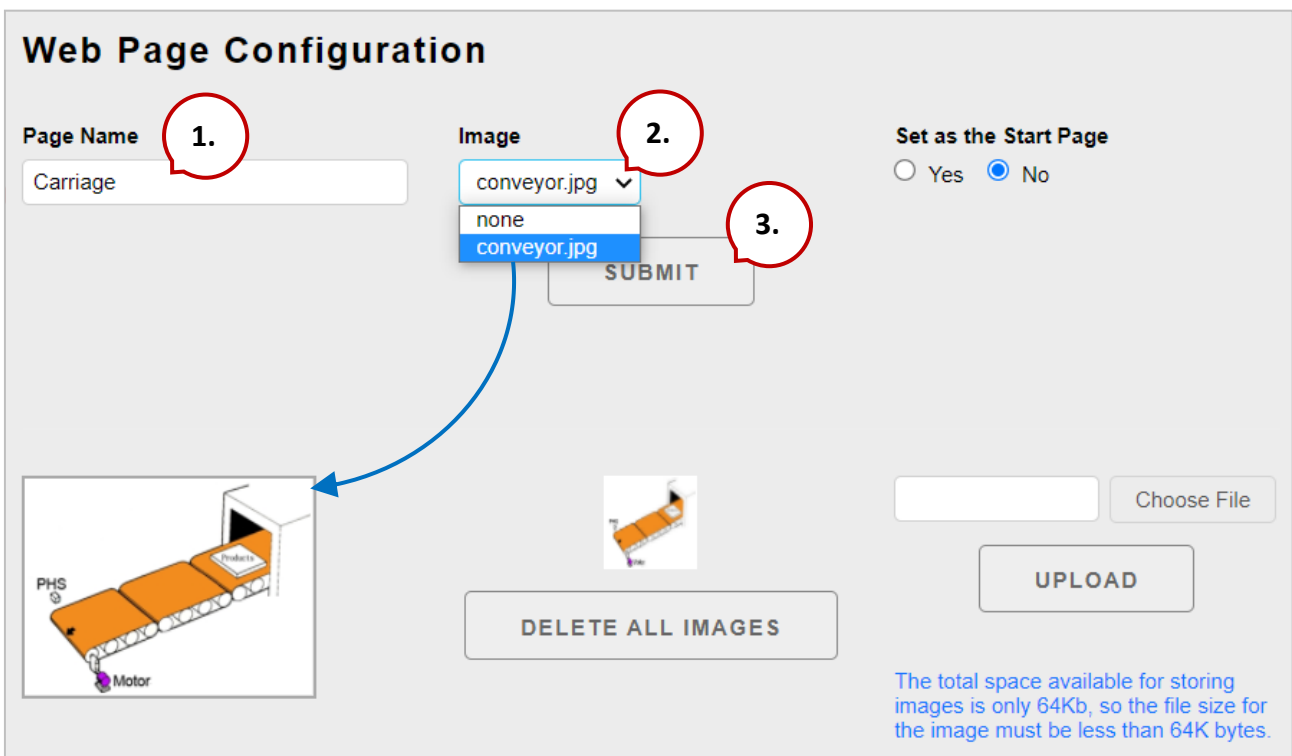

Step 4: Add a Modbus Register Item to be used to read the selected sensor input

On the **Carriage** page, click the **"Edit"** button in the first row to display the **"Edit Group Register"** page.

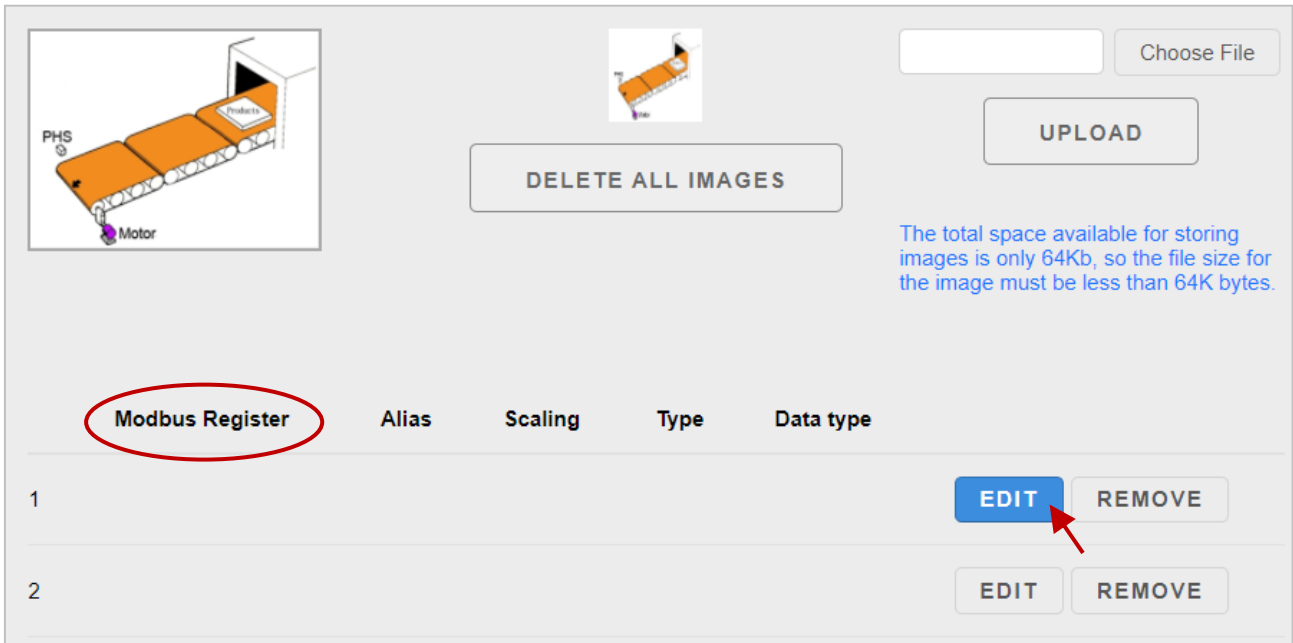

The screenshot shows the Carriage page interface. At the top, there is a diagram of a carriage with a 'PHS' sensor and a 'Motor'. Below the diagram is a 'DELETE ALL IMAGES' button. To the right, there is a 'Choose File' button and an 'UPLOAD' button. A note states: 'The total space available for storing images is only 64Kb, so the file size for the image must be less than 64K bytes.' Below this is a table with the following columns: **Modbus Register**, **Alias**, **Scaling**, **Type**, and **Data type**. The table has two rows. The first row has an 'EDIT' button highlighted with a red arrow and a 'REMOVE' button. The second row has 'EDIT' and 'REMOVE' buttons.

Step 5: Add a DI register that is to be used to read "PHS" inputs

Set the PHS as a DI tag (use the **Modbus Register "0"**, i.e., DI0).

Set the **Register Type** to **"Discrete Input"** (Read) and enter **"PHS1"** in the **Alias** field. Then, click the **SUBMIT** button to save the settings.

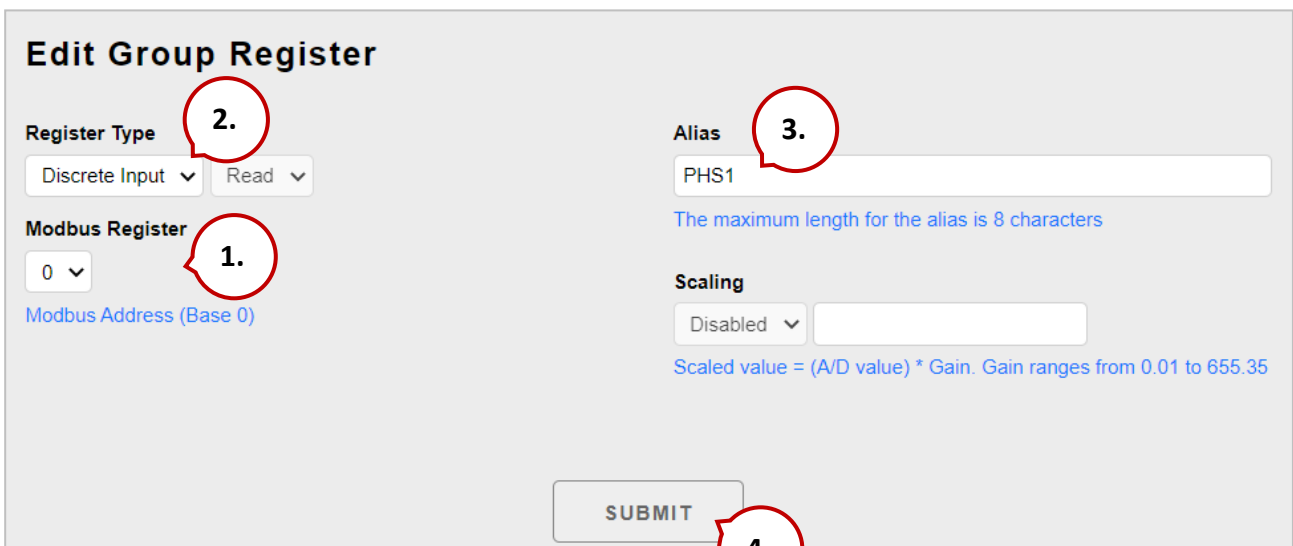
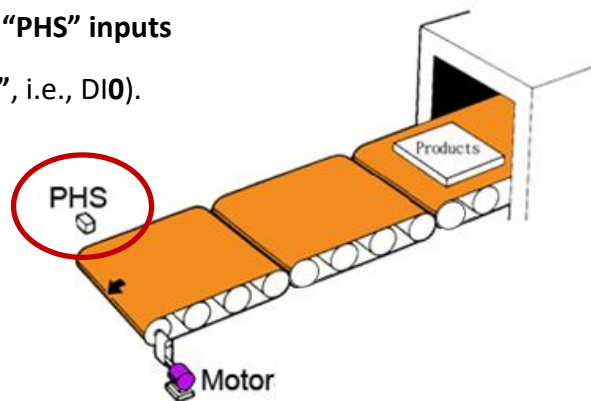

The screenshot shows the 'Edit Group Register' page. The 'Register Type' is set to 'Discrete Input' and 'Read'. The 'Modbus Register' is set to '0'. The 'Alias' field contains 'PHS1'. The 'Scaling' is set to 'Disabled'. A 'SUBMIT' button is at the bottom. Numbered callouts are present: 1. points to the 'Modbus Register' dropdown, 2. points to the 'Register Type' dropdowns, 3. points to the 'Alias' field, and 4. points to the 'SUBMIT' button.

Now, a new Register item will be displayed in the list. To edit the item, click the **“EDIT”** button to access the **Edit Group Register** page, or to remove the item, click the **“REMOVE”** button.

The screenshot shows a configuration page for Modbus Registers. At the top, there are image upload controls: a 'Choose File' button, an 'UPLOAD' button, and a 'DELETE ALL IMAGES' button. A note states: 'The total space available for storing images is only 64Kb, so the file size for the image must be less than 64K bytes.' Below this is a table of registers:

	Modbus Register	Alias	Scaling	Type	Data type	
1	00000	PHS1	0	Coil	Boolean	EDIT REMOVE

Step 6: Add a Modbus Register Item to be used to write the selected motor output

Click the **“Edit”** button in the second row of the list, and the **“Edit Group Register”** page will be displayed.

The screenshot shows the same configuration page as above, but with a new register added. The table now has three rows:

	Modbus Register	Alias	Scaling	Type	Data type	
1	10000	PHS1	0	Discrete Input	Boolean	EDIT REMOVE
2						EDIT REMOVE
3						EDIT REMOVE

Step 7: Add a DO that is to be used to write the “Motor” output to turn the conveyor motor on and off

Set the Motor as a DO tag (use the **Modbus Register “0”**, i.e., DO0).

Set the **Register Type** to **“Coil”** and **“Write”** and enter **“ Motor”** in the **Alias** field. Then, click the **SUBMIT** button to save the settings.

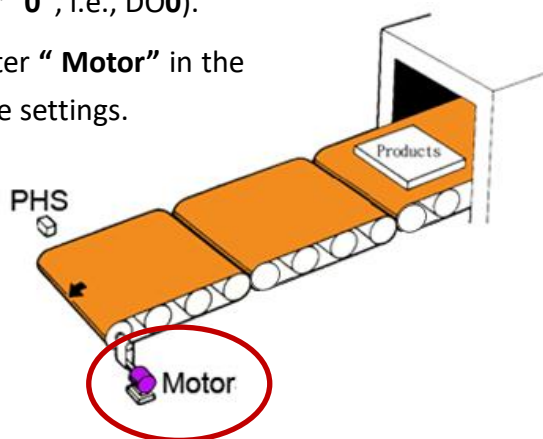

Edit Group Register

Register Type: **2.**

Modbus Register: **1.**
Modbus Address (Base 0)

Alias: **3.**
The maximum length for the alias is 8 characters

Scaling:
Scaled value = (A/D value) * Gain. Gain ranges from 0.01 to 655.35

4.

Step 8: Add an AI that is to be used to read the speed of the conveyor (In this case, 0-2.5 m/s)

Set the Speed as an AI tag (use the **Modbus Register "0"**, i.e., AI0).

(See the figure on the next page)

1. Set the **Register Type** to **"Input"** (Read).
2. Enter **"Speed"** in the **Alias** field.
3. Set the **Scaling** as **"Enabled"** and enter the **Gain** value as **"0.25"** (i.e., $2.5/10 = 0.25$).

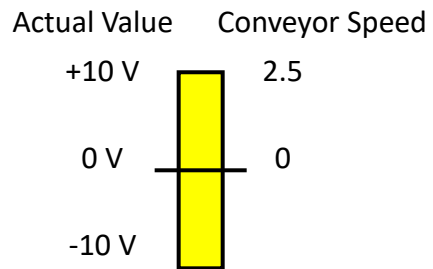

In this example, the **Range** of AIO is set to **"-10 ~ 10V"** and the **Data Format** is set to **"Engineering"**. For more information about the setting, refer to Section 3.2.3 – (E) Analog Input Settings (P49).

Overview Analog Input Settings

Configuration

Network Settings

Basic Settings

Module I/O Settings

Channel	Enable	Disable	Range
Ch0	<input checked="" type="radio"/>	<input type="radio"/>	08, -10 ~ 10 V
Ch1	<input checked="" type="radio"/>	<input type="radio"/>	08, -10 ~ 10 V

Modbus Address	Function	Normal mode	Fast mode
00628	Normal Mode (10 Hz)/Fast Mode (50 Hz)	<input checked="" type="radio"/>	<input type="radio"/>
00629	60/50 Hz Rejection	<input checked="" type="radio"/>	<input type="radio"/>
00631	Data Format	<input type="radio"/>	<input checked="" type="radio"/>

4. Click the **SUBMIT** button to save the settings.

Edit Group Register

Register Type
Input Read

Alias
Speed
The maximum length for the alias is 8 characters

Modbus Register
0
Modbus Address (Base 0)

Scaling
Enabled 0.25
Scaled value = (A/D value) * Gain. Gain ranges from 0.01 to 655.35

Step 9: Browse the “Carriage” web page

After clicking the Web HMI item, you can click on the **Carriage** tab to see the added page.

Overview

Configuration +

Authentication +

Web HMI -

Web HMI

Web Edit

Pair Connection

More Information

	Modbus Register	Alias	Scaling	Type	Data type	
1	10000	PHS1	0	Discrete Input	Boolean	<input type="button" value="EDIT"/> <input type="button" value="REMOVE"/>
2	00000	Motor	0	Coil	Boolean	<input type="button" value="EDIT"/> <input type="button" value="REMOVE"/>
3	30000	Speed	0.25	Input	Signed 16	<input type="button" value="EDIT"/> <input type="button" value="REMOVE"/>

The total space available for storing images is only 64Kb, so the file size for the image must be less than 64K bytes.

AI AO DI DO **CARRIAGE**

carriage

PHS
Motor

Channel No.	Alias	Status	Action
DI0	PHS1	OFF	
DO0	Motor	OFF	<input type="button" value="OFF"/> <input type="button" value="ON"/>
AI0	Speed	0.0	

On the **Carriage** page, you can click the control button of the motor to set it as ON. For testing, when the AI value is “5”, the value will be converted to a conveyor speed of $5 \times 0.25 = 1.25$ (m/s)

Overview THIS COMPUTER -  - ET-7000

Configuration +

Authentication +

Web HMI -

Web HMI

Web Edit

Pair Connection

More Information

AI AO DI DO **CARRIAGE**

carriage

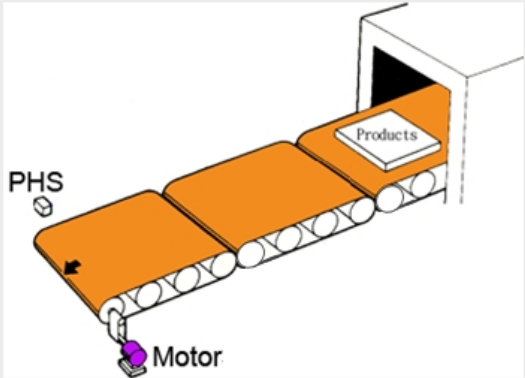

Channel No.	Alias	Status	Action
DI0	PHS1	OFF	
DO0	Motor	ON	OFF ON 
AI0	Speed	1.25	

3.5. I/O Pair Connection

The "Pair Connection" feature enables configuring connections between remote and local I/O, facilitating the remote transmission of input data to output channels.

Overview	
Configuration	—
Network Settings	
Basic Settings	
Module I/O Settings	
Authentication	—
Account Management	
Accessible IP Settings	
Web HMI	—
Web HMI	
Web Edit	
Pair Connection	
Maintenance	—
Import / Export Configuration	
More Information	
Logout	

The **pair connection** function is a particular feature of the ET-7x00/PET-7x00 module that can be used to enable a pair of DI-to-DO (or AI-to-AO) via Modbus TCP.

With the pair connection function enabled, the ET-7x00/PET-7x00 module can poll the status of remote input devices using the Modbus/TCP protocol and then continuously write to its output channels in the background.

The **Pair Connection** function consists of the following parameters:

Configuration of Communication

Connection Timeout (ms)	Reconnect Interval (ms)
<input type="text" value="2000"/>	<input type="text" value="3000"/>

Connection Timeout: The (P)ET-7x00 module wait for a connection to the remote module for a specified period of time.

Reconnect Interval: The (P)ET-7x00 module attempt to reconnect to the remote module at specified intervals.

Remote DI to Local DO
 Disable

Communication Timeout (ms)	IP Address of the Remote Device
<input type="text" value="1000"/>	<input type="text" value="192.168.255.200"/>
Scan Time (ms)	Modbus TCP Port
<input type="text" value="1000"/>	<input type="text" value="502"/>
Local DO Base Address	Modbus ID
<input type="text" value="0"/>	<input type="text" value="1"/>
I/O Count	Remote DI Base Address
<input type="text" value="8"/>	<input type="text" value="0"/>

Communication Timeout (ms):

The (P)ET-7x00 module wait for a response from the remote module for a specified period of time.

IP Address of the Remote Device:

The IP address of the remote module.

Scan Time (ms):

The polling frequency of the remote module.

Modbus TCP Port:

The Modbus TCP Port of the remote module.

Local DO Base Address:

The start number of the local DO channel, used for mapping to the remote DI channel.

Modbus ID:

The Modbus Net ID of the remote module.

I/O Count:

The count of mapped I/O channels starting from the initial channel number.

Remote DI Base Address:

The start number of the remote DI channel, used for mapping to the local DO channel.

Remote AI to Local AO

Disable

Communication Timeout (ms): 1000

IP Address of the Remote Device: 192.168.255.200

Scan Time (ms): 1000

Modbus TCP Port: 502

Local AO Base Address: 0

Modbus ID: 1

I/O Count: 8

Remote AI Base Address: 0

SUBMIT

Except for these two items, all descriptions are the same as noted before.

Local AO Base Address:

The start number of the local AO channel, used for mapping to the remote AI channel.

Remote AI Base Address:

The start number of the remote AI channel, used for mapping to the local AO channel.

3.5.1. Example 1: Pair Connection - AI to AO

This example will describe how to use this feature to achieve remote AI/AO mapping between two I/O modules.

Hardware Devices:

1. PET-7026 (with AI, AO, DI, and DO)
2. ET-7017 (with AI and DO)
3. PoE Ethernet Switch
4. Power Supply (24 V)
5. Power Supply (48 V)

Hardware Connections:

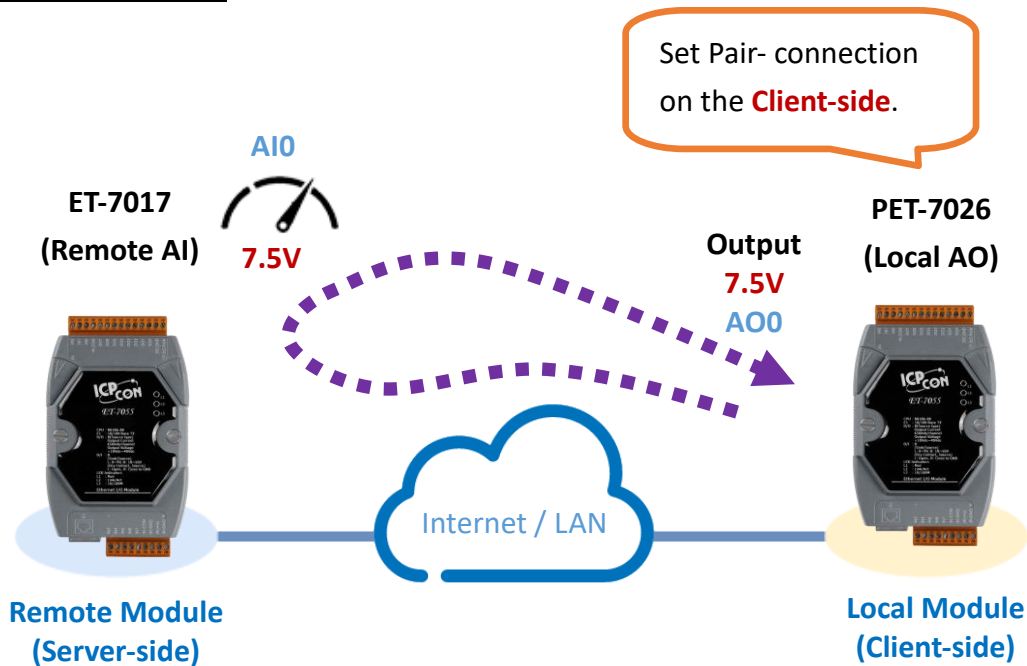

Software Configuration:

The following provides step-by-step instructions for how to configure the ET-7x00/PET-7x00 via the built-in web interface.

In this example, we will configure the PET-7026's settings page to map its AO to the ET-7017's AI. Then, when the ET-7017's AI receives 7.5V, the PET-7026's AO will automatically output 7.5V.

Step 1: Log in to the PET-7026 web interface

Enter the IP address of the PET-7026 in the browser, and then enter your user name and password to log in to the PET-7026 web interface. Refer to chapter 3, “Web Applications”, for more details.

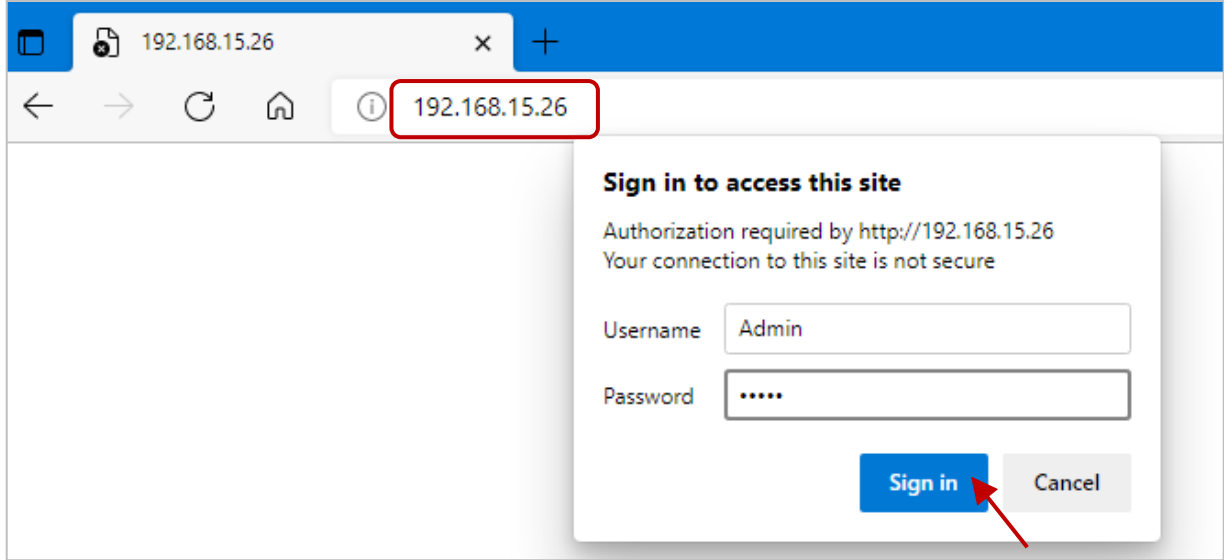

Step 2: Configure the AO type for the PET-7026

Click the “Module I/O Settings” option in the Configuration menu and set the voltage (or current) range to “-10 ~ 10V” in the “Analog Output Settings” section. Then, click the “Submit” button. Follow the same procedure to set the AI range for the ET-7017.

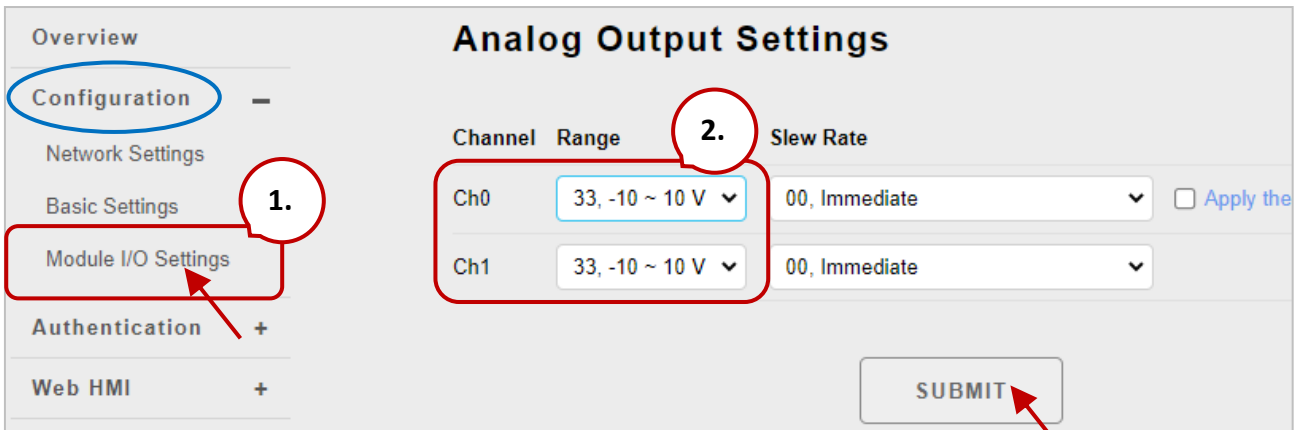

Tips & Warnings



The settings for both the AO type for the PET-7026 and the AI type for the ET-7017 must be the same. In this example, they are both “-10 ~ 10V”.

Step 3: Configure the Modbus Settings for the PET-7026

Click the **“Pair Connection”** option in the main menu and enter the details noted in the table below into the respective fields.

Field	Settings						
<div style="border: 1px solid gray; padding: 10px; width: fit-content; margin: auto;"> <h3 style="margin: 0;">Configuration of Communication</h3> <div style="display: flex; justify-content: space-around; margin-top: 10px;"> <div style="text-align: center;"> <p>Connection Timeout (ms)</p> <input style="width: 150px;" type="text" value="3000"/> </div> <div style="text-align: center;"> <p>Reconnect Interval (ms)</p> <input style="width: 150px;" type="text" value="5000"/> </div> </div> </div>							
Connection Timeout	3000 ms						
Reconnect Interval	5000 ms						
Remote AI to Local AO							
Click the toggle button to enable the I/O pair connection functions. (See the next page)							
Communication Timeout (1000 to 12000)	2000 ms						
Scan Time (1000 to 30000)	2000 ms						
Local AO Base Address	0 (Starting from AO0 on the PET-7026)						
I/O Count	2 (Using AO0, AO1 and AI0, AI1)						
IP Address of the Remote Device	The IP address of the ET-7017 module. (e.g. 192.168.15.17)						
Modbus TCP Port	502						
Modbus ID	1 (Default = 1, the Net ID for the ET-7017)						
<p>To determine the Net ID, check the “Modbus Definition” section which can be found by clicking the “Module I/O Settings” option in the “Configuration” menu.</p> <div style="border: 1px solid gray; padding: 10px; margin-top: 10px;"> <div style="display: flex;"> <div style="width: 20%; padding-right: 10px;"> <p>Overview</p> <p>Configuration —</p> <p>Network Settings</p> <p>Basic Settings</p> <p>Module I/O Settings —</p> <p>Authentication —</p> </div> <div style="width: 80%;"> <h3 style="margin: 0;">Modbus Definition</h3> <table border="1" style="width: 100%; border-collapse: collapse;"> <thead> <tr> <th style="width: 30%;">Modbus Address</th> <th style="width: 40%;">Function</th> <th style="width: 30%;"></th> </tr> </thead> <tbody> <tr> <td style="text-align: center;">40271</td> <td style="text-align: center;">Modbus Unit ID</td> <td style="text-align: center;"> <input style="width: 100px;" type="text" value="1"/> 0~255 (default:1) </td> </tr> </tbody> </table> <div style="text-align: right; margin-top: 10px;"> <input type="button" value="SUBMIT"/> </div> </div> </div> </div>		Modbus Address	Function		40271	Modbus Unit ID	<input style="width: 100px;" type="text" value="1"/> 0~255 (default:1)
Modbus Address	Function						
40271	Modbus Unit ID	<input style="width: 100px;" type="text" value="1"/> 0~255 (default:1)					
Remote AI Base Address:	0 (Starting from AI0 on the ET-7017)						

After completing the configuration, click the “**Submit**” button to save the settings.

Testing:

Before starting the test, confirm that the data format of ET-7017 is the same as that of PET-7026. To do this, click the “**Module I/O Settings**” option in the “**Configuration**” menu and check the “**Range**” setting in the “**Analog Input Settings**” section.

To supply +7.5V to AI0 and +5.5V to AI1 on the ET-7017 and click the “**Web HMI**” item in the “**Web HMI**” menu.

The wiring for ET-7017 in this example:

ET-7017	External Power	ET-7017	External Power
Vin0+	→ +Vs (7.5V)	Vin1+	→ +Vs (5.5V)
Vin0-	→ GND	Vin1-	→ GND

Click the “AI” tab on the **Web HMI** page of the ET-7017. As shown in the figure below, AI0 received about 7.5V. AI1 received about 5.5V.

ET-7017 THIS COMPUTER - ET-7000

AI DO

Analog Inputs

Channel No.	Actual Value	Historical Max/Min Value		High/Low Alarm	
AI0	7.494 V Modbus 30000: 1D46	Max: 7.494 V Modbus 30236: 1D46	Min: -0.022 V Modbus 30268: FFEA	High Alarm: OFF Modbus 10224: 0	Low Alarm: OFF Modbus 10256: 0
AI1	5.494 V Modbus 30001: 1576	Max: 5.499 V Modbus 30237: 157B	Min: 0.0 V Modbus 30269: 0000	High Alarm: OFF Modbus 10225: 0	Low Alarm: OFF Modbus 10257: 0
AI2	0.0 V Modbus 30002: 0000	Max: -10.0 V Modbus 30238: D8F0	Min: 10.0 V Modbus 30270: 2710	High Alarm: OFF Modbus 10226: 0	Low Alarm: OFF Modbus 10258: 0

Next, click the “AO” tab on the **Web HMI** page of the ET-7026 and you can see that AO0 outputs about 7.5 V and AO1 outputs about 5.5V. automatically.

ET-7026 THIS COMPUTER - ET-7000

AI AO DI DO CARRIAGE PAIR CONNECTION

Analog Outputs

Channel No.	Actual Value	Output Value	Action
AO0	7.496 V Modbus 40232: 1D48	<input type="text"/> -10 ~ 10 V Modbus 40000: 0000	APPLY
AO1	5.493 V Modbus 40233: 1575	<input type="text"/> -10 ~ 10 V Modbus 40001: 0000	APPLY

3.5.2. Example 2: Pair Connection - DI to DO

In this example, we will show how to use this feature to achieve remote DI/DO mapping between two I/O modules.

Hardware devices:

1. PET-7026 (with AI, AO, DI, and DO)
2. PET-7044 (with DI and DO)
3. PoE Switch
4. Power Supply (48 V).

Hardware Connections:

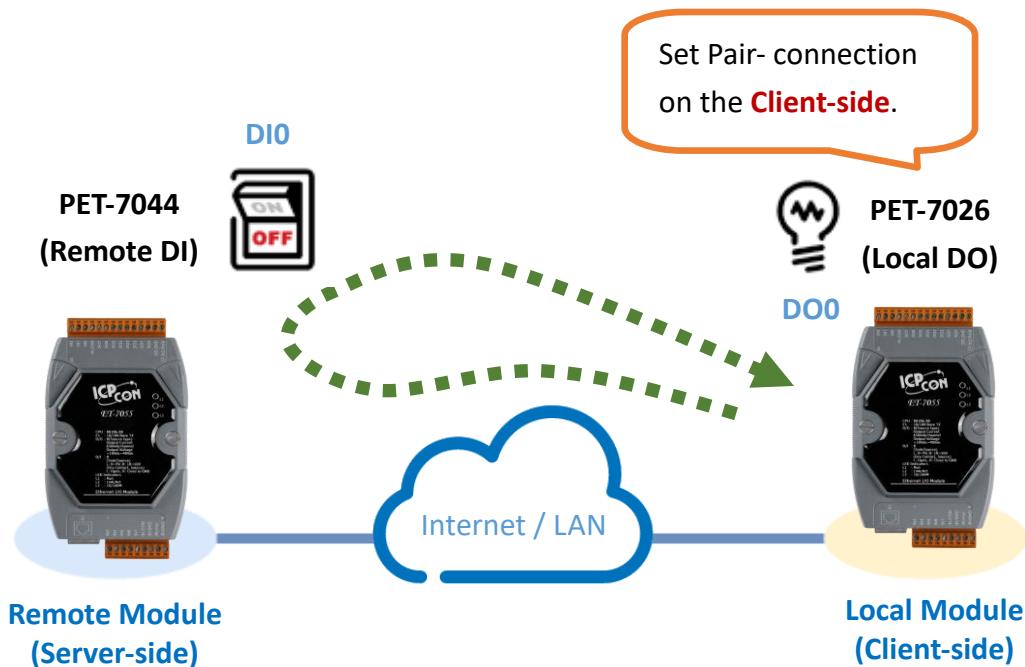

Software Configuration:

The following provides step-by-step instructions for how to configure the ET-7x00/PET-7x00 via the built-in web interface.

In this example, we will configure the settings page of PET-7026 to map its DO to the DI of PET-7044. Then, when the DI status of PET-7044 changes to ON, the DO of PET-7026 will automatically be set to ON.

Step 1: Log in to the PET-7026 web interface

Enter the IP address of the PET-7026 in the browser, and then enter your user name and password to log in to the PET-7026 web interface. Refer to chapter 3, “Web Applications”, for more details.

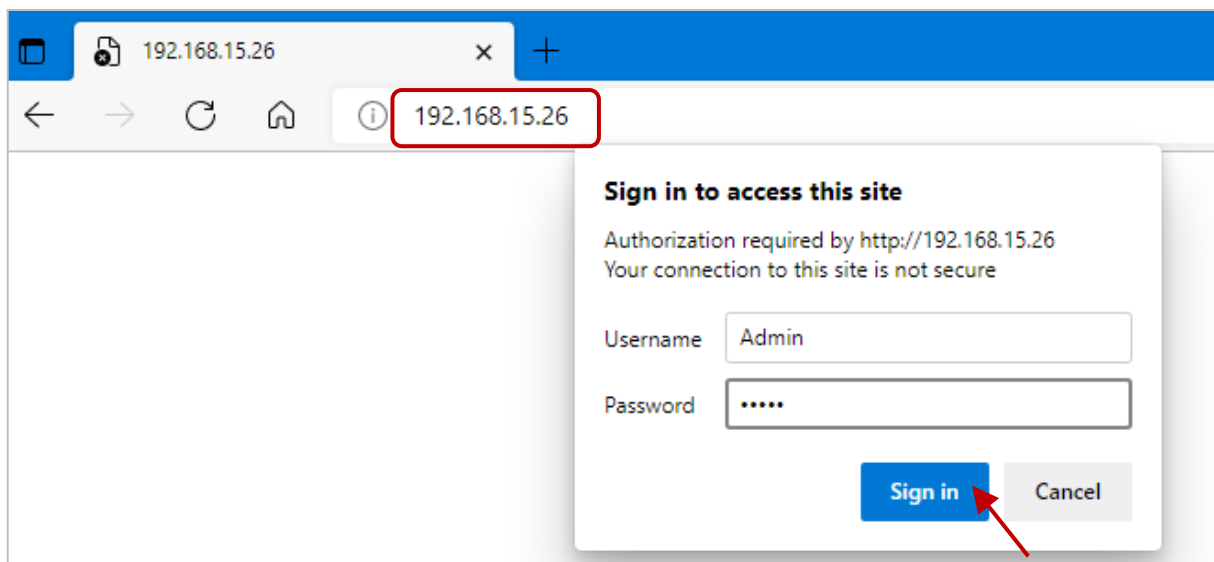

Step 2: Configure the Modbus Settings for the PET-7026

Click the “Pair Connection” option in the Main Menu, and enter the details listed in the table below into the respective fields.

Field	Settings
Configuration of Communication	
Connection Timeout (ms)	3000
Reconnect Interval (ms)	5000
Connection Timeout	3000 ms
Reconnect Interval	5000 ms
Remote DI to Local DO	
Click the toggle button to enable the I/O pair connection functions.	
Communication Timeout (1000 to 12000)	1000 ms
Scan Time (1000 to 30000)	1000 ms
Local DO Base Address	0, starting from DO0 on the PET-7026
I/O Count	2, using DO0, DO1, and DI0, DI1

IP Address of the Remote Device	The IP address of the PET-7044 module. (e.g. 192.168.15. 44)
Modbus TCP Port	502
Modbus ID	1 (Default = 1, the Net ID for the PET-7044)

To determine the Net ID, check the **“Modbus Definition”** section which can be found by clicking the **“Module I/O Settings”** option in the **“Configuration”** menu.

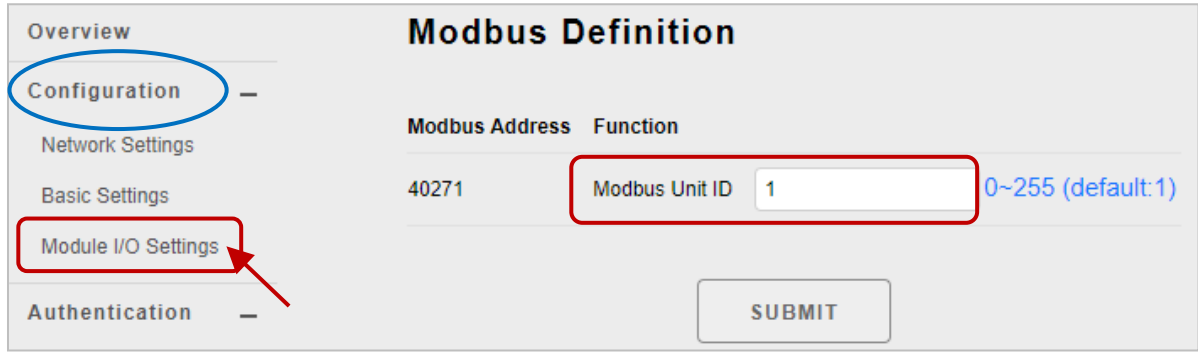

Remote DI Base Address:	0 (Starting from DIO on the PET-7044)
-------------------------	---------------------------------------

After completing the configuration, click the **“Submit”** button to save the settings.

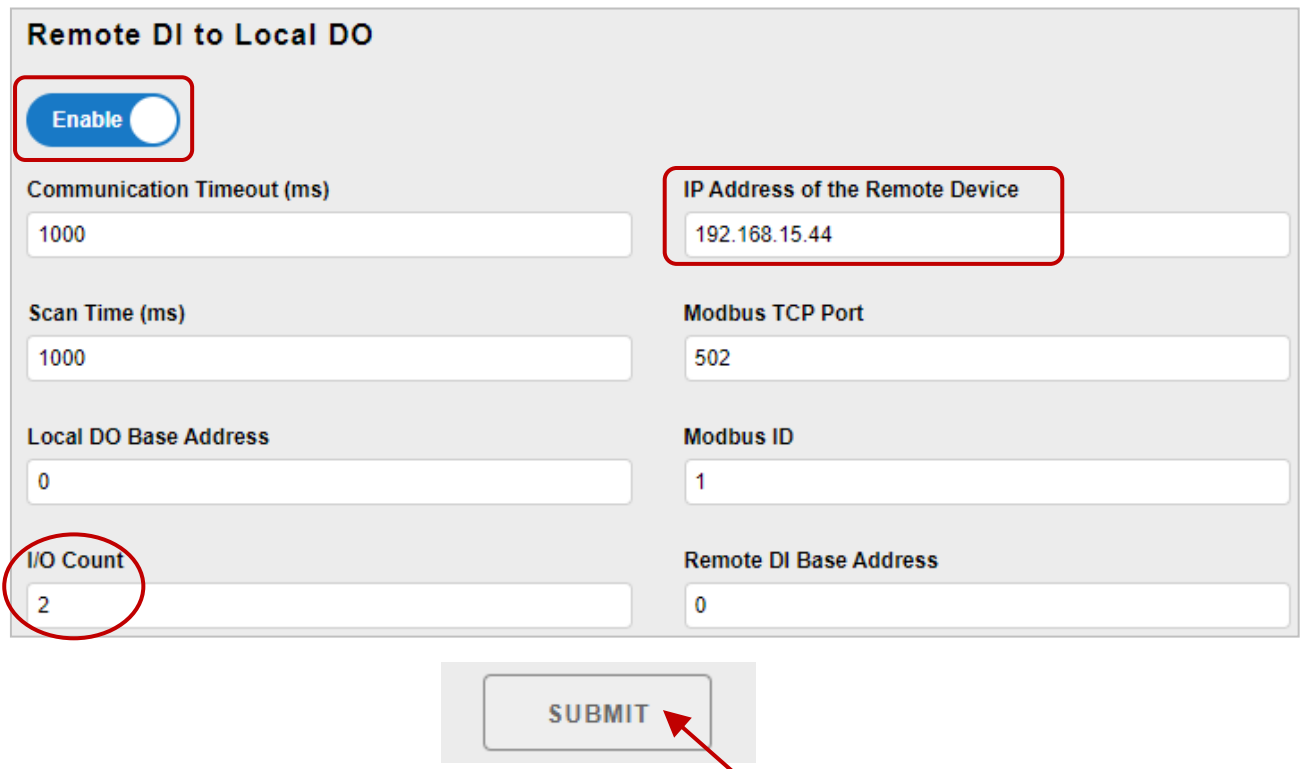

For Testing the function:

The user can view the Wire Connection in the data sheet on [the product page](#). In this example, the wiring of the PET-7044 is shown below.

PET-7044		External Power
IN0	→	DO0
IN1	→	DO1
IN.COM	→	DO.PWR
		DO.PWR → Vs (24V, 10 – 50V)
		DO.GND → GND

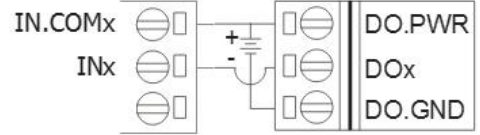

On the **Web HMI** page of the PET-7044. Depending on the wiring above, if DO1 is set to ON, DI1 will become ON.

The screenshot shows the Web HMI interface for the PET-7044. On the left, there is a navigation menu with options: Overview, Configuration, Authentication, Web HMI, and Web Edit. The 'Web HMI' option is selected and highlighted with a red box. The main area is divided into two sections: 'Digital Inputs' and 'Digital Outputs'.

Digital Inputs Table:

Channel No.	Modbus Register	Status	Counter	High Latched	Low Latched
DI0	10000	OFF	-	-	-
DI1	10001	ON	-	-	-
DI2	10002	OFF	-	-	-

The 'ON' status for DI1 is circled in red with the number '2.' next to it. The entire row for DI1 is also highlighted with a red box.

Digital Outputs Table:

Channel No.	Modbus Register	Status	Action
DO0	00000	OFF	OFF ON
DO1	00001	ON	OFF ON

The 'ON' status for DO1 is circled in red with the number '1.' next to it. The 'ON' button in the 'Action' column for DO1 is also circled in red with an arrow pointing to it. The entire row for DO1 is highlighted with a red box.

On the “**Web HMI - DO**” page of PET-7026, the status of DO1 becomes ON automatically.

The screenshot shows the 'Web HMI - DO' page for the ET-7000. At the top, it says 'THIS COMPUTER - ET-7000'. Below that, there are buttons for AI, AO, DI, and DO. The 'DO' button is circled in red. To the right of these buttons is a 'PAIR CONNECTION' button. Below this is the 'Digital Outputs' section.

Digital Outputs Table:

Channel No.	Modbus Register	Status	Action
DO0	00000	OFF	OFF ON
DO1	00001	ON	OFF ON

The 'ON' status for DO1 is circled in red. The entire row for DO1 is highlighted with a red box.

3.6. Maintenance

The function is supported since the firmware version 3.11.

Import / Export Configuration:

Used to import or export the configuration file of the I/O module.

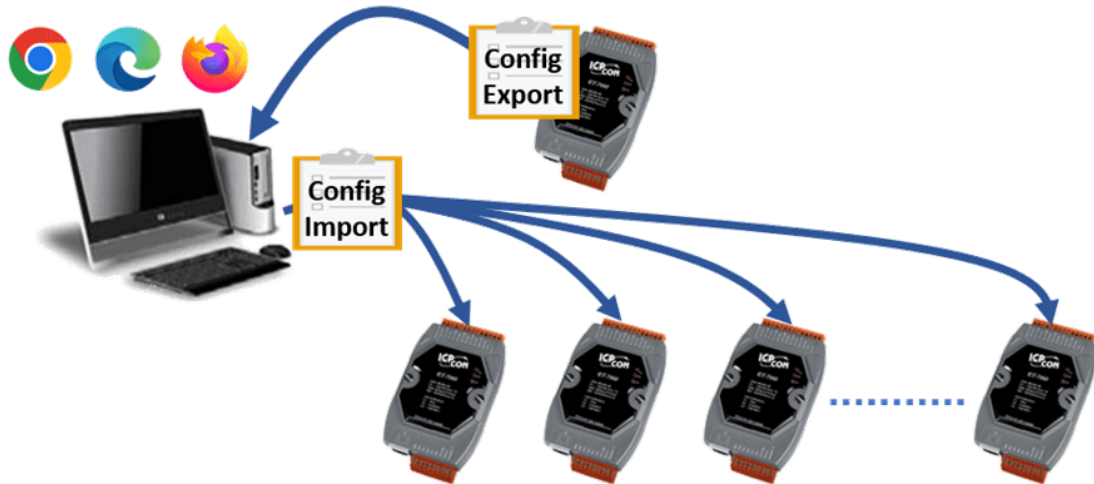

The “Maintenance” menu as below:

Overview	
Configuration	+
Authentication	+
Web HMI	+
Pair Connection	
Maintenance	-
Import / Export Configuration	
More Information	
Logout	

The “**Import / Export Configuration**” page allows users to import or export the configuration file of the module.

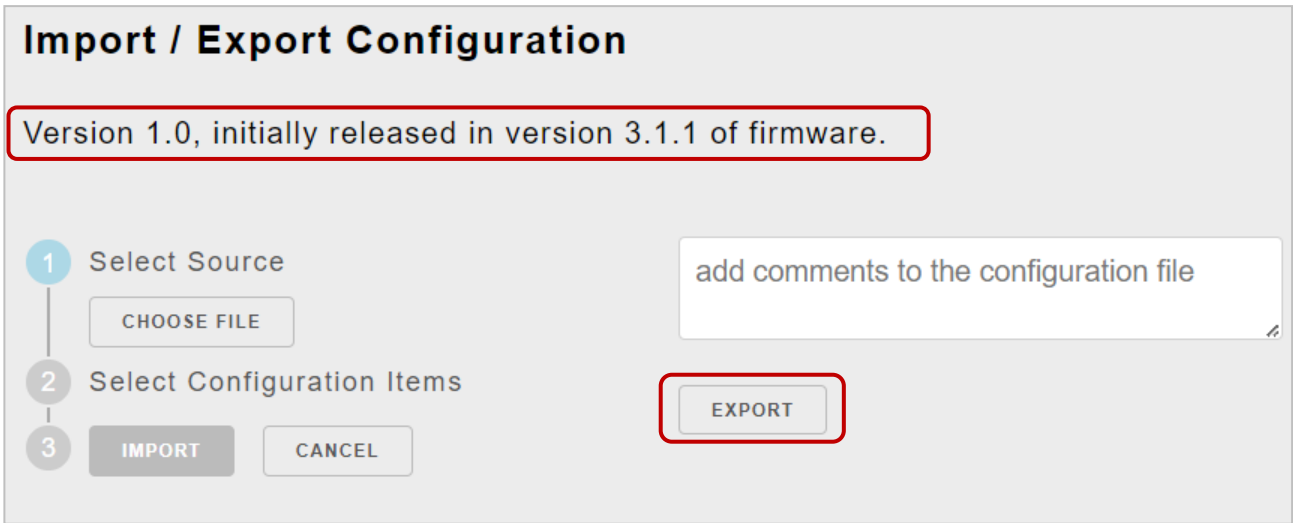

Export the Configuration

After completing the module settings, the user can add some notes in the text box and then click the “**Export**” button to export the configuration file. The file will be saved in your default download location.

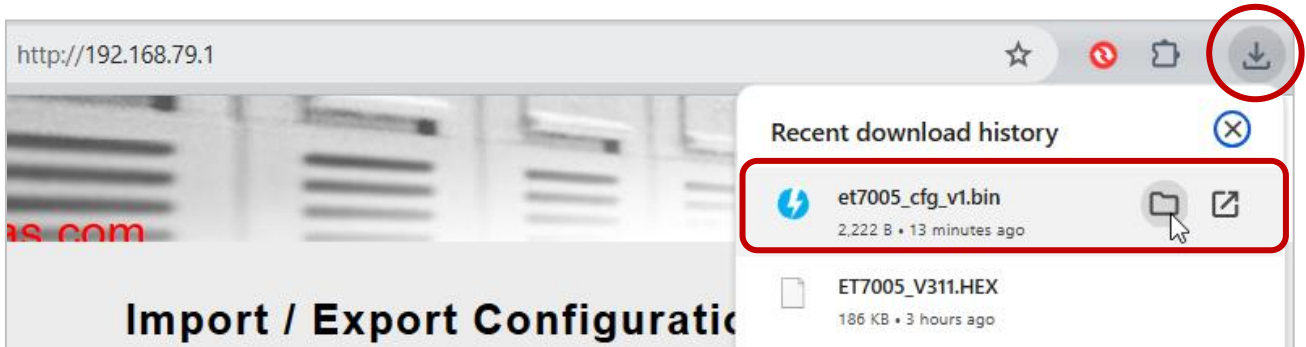
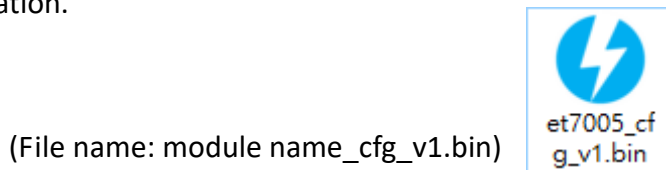

Import the Configuration

Step 1: Click the “**Choose File**” button.

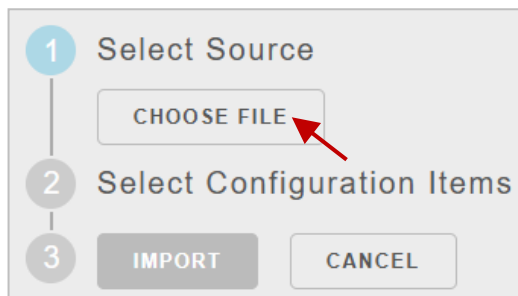

Step 2: Choose the file (.bin) to be imported, and then click the “Open” button.

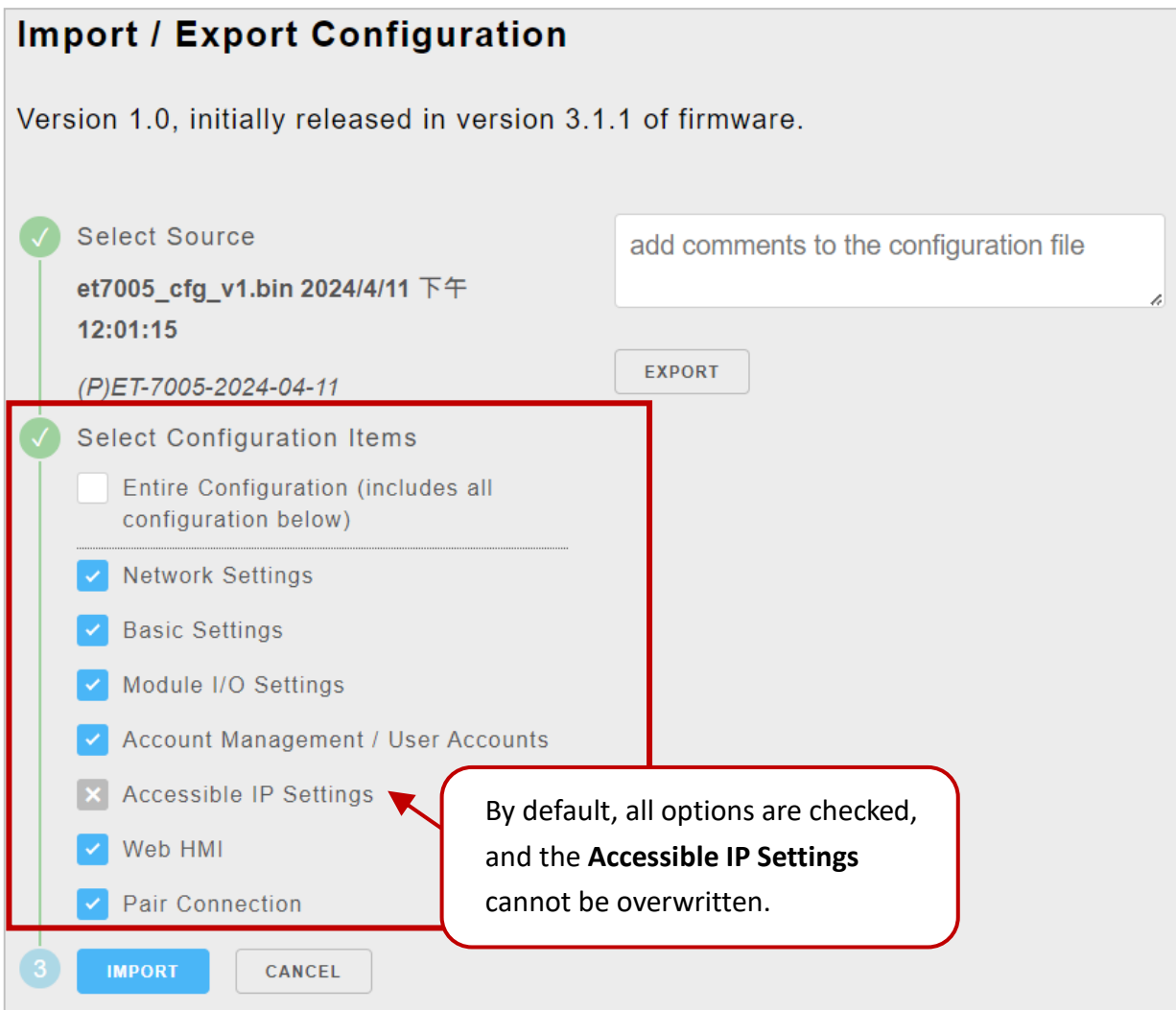
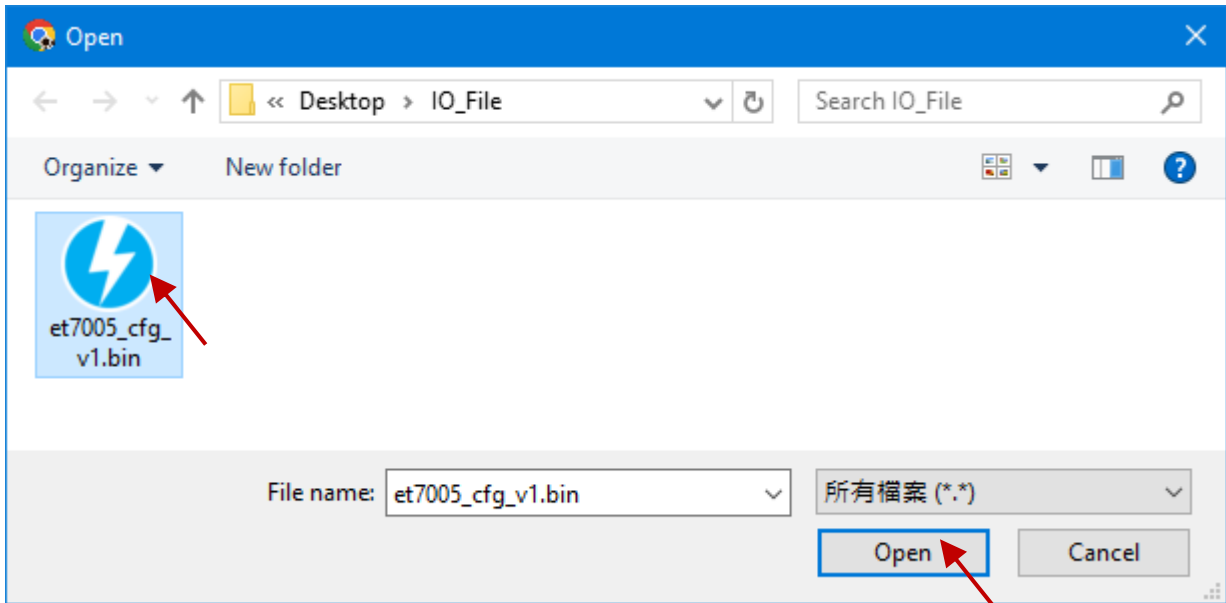

Users can uncheck unwanted items or select only the "Entire Configuration" option, which includes all default checked options.

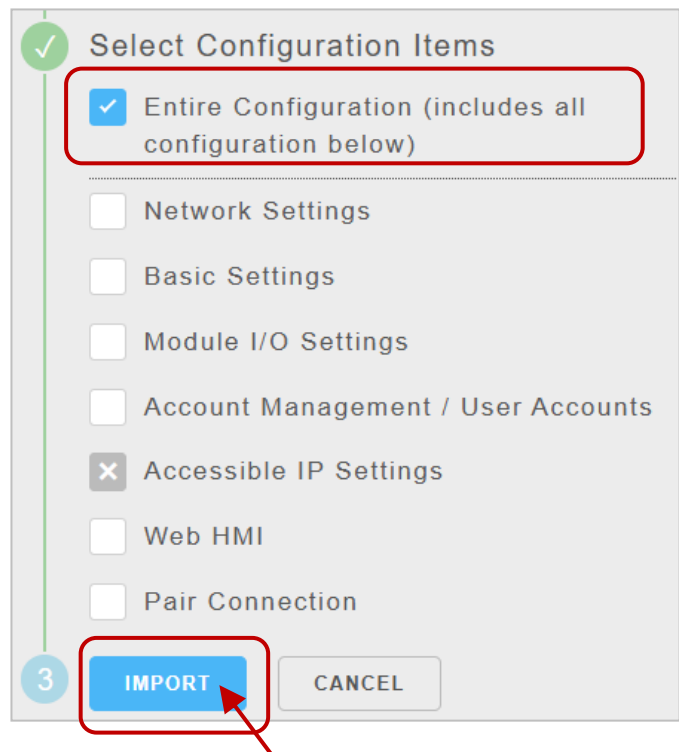

Step 3: Click the “**Import**” button, and the prompt message will appear based on the module settings. Users can review the imported configuration values again.

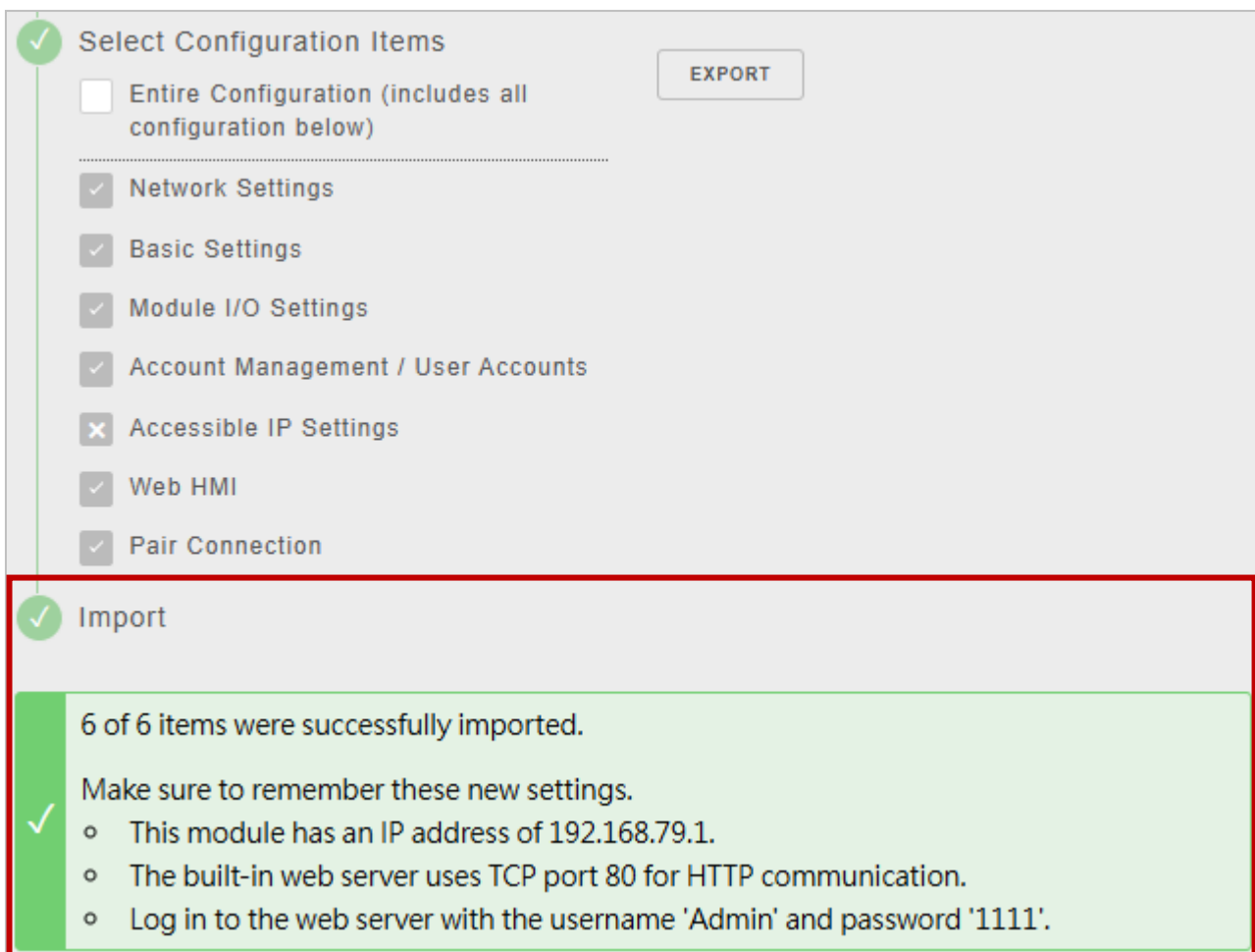

3.7. More Information

The “More Information” option in the main menu can be used to open the ICP DAS site in your browser. The default URL is <http://www.icpdas.com>.



Also, refer to Section 3.2.2 Basic Settings to modify the URL if it is necessary.

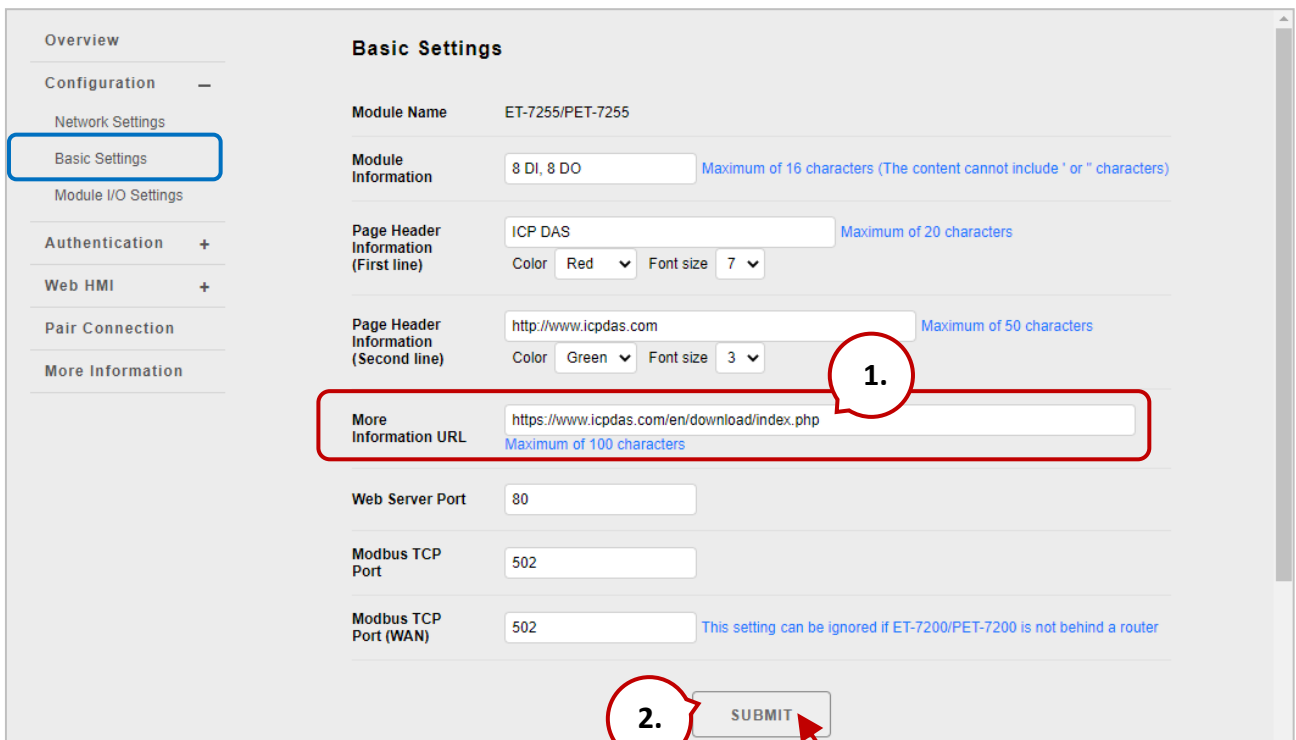

Chapter 4. Modbus TCP/IP

With the support of the Modbus TCP protocol, the (P)ET-7000/(P)ET-7200 series module can send Modbus data via Ethernet for remote I/O monitoring applications. Modbus TCP is an Ethernet communication based on the Master/Slave (or Client/Server) architecture. The Master sends a query or control command, and the Slave executes the Master's request according to the function code in the command and then responds with a message to the Master.

The Modbus TCP Client connects to the (P)ET-7x00 with standard TCP/IP communication. Up to 12, Modbus TCP connections are available at one time for a (P)ET-7x00. Visit the website <http://www.modbus.org> for more information about the Modbus protocol.

4.1. Modbus TCP/IP Message Format

Modbus TCP ADU consists of the Modbus Application Protocol (MBAP) Header and the Modbus PDU. When sending a Modbus message, the MBAP header is used for identifying the Modbus TCP package.

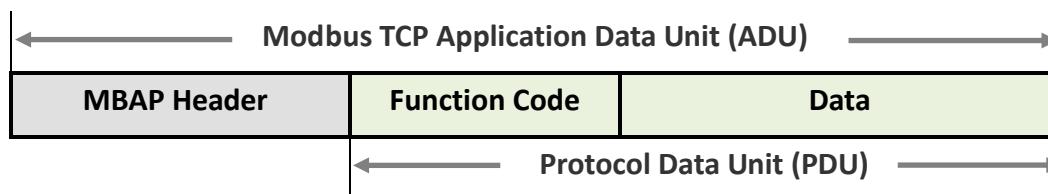

MBAP Header

Field	Length	Description
Transaction Identifier	2 bytes	Specified by Modbus TCP Master (Client)
Protocol Identifier	2 bytes	0 = Modbus protocol
Length Field	2 bytes	Number of following bytes (Counting from the Unit Identifier to the last data of PDU)
Unit Identifier	1 byte	Identification of the remote Slave device

Function Code

Modbus TCP supports several function codes, and the Slave device can perform actions according to function codes. The Modbus/TCP feature of the ET-7x00/PET-7x00 series module supports eight function codes, which allows read/write data from/to the register.

Function Code	Function
01 (0x01)	Read Coil Status
02 (0x02)	Read Input Status
03 (0x03)	Read Holding Registers
04 (0x04)	Read Input Registers
05 (0x05)	Force Single Coil
06 (0x06)	Preset Single Register
15 (0x0F)	Force Multiple Coils
16 (0x10)	Preset Multiple Registers

Any function codes that are not supported by ET-7000/ET-7200 will be replied to with an exception code to inform the Client to do appropriate actions

Data

The data field is used to specify the register's address of the Slave device to be accessed. In addition, the data field needs to contain the necessary information according to the function code, such as the number of registers to be accessed.

Response

When the Master sends a request to the Slave device, the following conditions may occur.

1. If the Slave receives the request and no communication error occurs, it will make a normal response.
2. If the Slave does not receive a request due to a communication error or if the unit ID in the request does not match, it will not respond.
3. If the Slave receives a request but the function code is not supported or the specified register address is incorrect, it will respond with an exception code to notify the Master for appropriate processing.

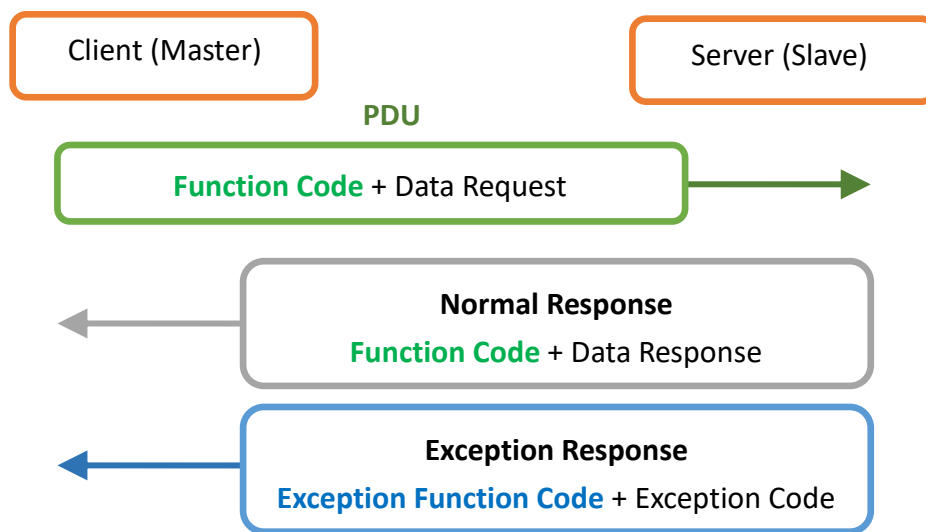

4.2. Function Code

4.2.1. 01 (0x01) Read Coils

This function code is used to read the status of digital outputs.

Here is an example of a request to read two digital outputs of the ET-7026/PET-7026 module:

Request			Response	
Field Name		(Hex)	Field Name	(Hex)
MBAP Header		01	MBAP Header	01
		02		02
		00		00
		00		00
		00		00
		06		04
Unit ID		01	Unit ID	01
Function Code		01	Function Code	01
Starting Address	Hi	00	Byte Count	01
	Lo	00	Outputs Status (0-1)	02
Channels	Hi	00		
	Lo	02		

The status of outputs in the Modbus response is expressed in hexadecimal 02, also binary 0000 00**10**. The LSB (Least Significant Bit) indicates the status of DO0 (0=OFF) and the bit1 indicates the status of DO1 (1=ON).

4.2.2. 02 (0x02) Read Discrete Inputs

This function code is used to read the status of digital inputs.

Here is an example of a request to read two digital inputs of the ET-7026/PET-7026 module:

Request			Response	
Field Name		(Hex)	Field Name	(Hex)
MBAP Header		01	MBAP Header	01
		02		02
		00		00
		00		00
		00		00
		06		04
Unit ID		01	Unit ID	01
Function Code		02	Function Code	02
Starting Address	Hi	00	Byte Count	01
	Lo	00	Digital Inputs Status (0-1)	03
Quantity of Inputs	Hi	00		
	Lo	02		

The status of inputs in the Modbus response is expressed in hexadecimal 03, also binary 0000 00**11**. The LSB (Least Significant Bit) indicates the status of DI0 (0=OFF) and the bit1 indicates the status of DI1 (1=ON).

4.2.3. 03 (0x03) Read Holding Registers

This function code is used to read the value of analog outputs.

Here is an example of a request to read two analog outputs of the ET-7026/PET-7026 module:

Request			Response		
Field Name		(Hex)	Field Name		(Hex)
MBAP Header		01	MBAP Header		01
		02			02
		00			00
		00			00
		00			00
		06			07
Unit ID		01	Unit ID		01
Function Code		03	Function Code		03
Starting Address	Hi	00	Byte Count		04
	Lo	00	Register Value (AO0)	Hi	02
Quantity of Outputs	Hi	00		Lo	2B
	Lo	02	Register Value (AO1)	Hi	00
		Lo		64	

The AO value is made up of 1 word (2 bytes). The AO0 value in the Modbus response is expressed in hexadecimal 022B, i.e., decimal 555. The AO1 value is expressed in hexadecimal 0064, i.e., decimal 100.

4.2.4. 04 (0x04) Read Inputs Registers

This function code is used to read the value of analog inputs.

Here is an example of a request to read two analog inputs of the ET-7026/PET-7026 module:

Request			Response		
Field Name		(Hex)	Field Name		(Hex)
MBAP Header		01	MBAP Header		01
		02			02
		00			00
		00			00
		00			00
		06			07
Unit ID		01	Unit ID		01
Function Code		04	Function Code		04
Starting Address	Hi	00	Byte Count		04
	Lo	00	Register Value (AI0)	Hi	00
Quantity of Inputs	Hi	00		Lo	0A
	Lo	02	Register Value (AI1)	Hi	00
		Lo		64	

The AI value is made up of 1 word (2 bytes). The AI0 value in the Modbus response is expressed in hexadecimal 000A, i.e., decimal 10. The AI1 value is expressed in hexadecimal 0064, i.e., decimal 100.

4.2.5. 05 (0x05) Write Single Coil

This function code is used to write a single DO to either ON or OFF.

Here is an example of a request to write DO1 of ET-7026/PET-7026 ON:

Request			Response		
Field Name	(Hex)		Field Name	(Hex)	
MBAP Header	01		MBAP Header	01	
	02			02	
	00			00	
	00			00	
	00			00	
	06			06	
Unit ID	01		Unit ID	01	
Function Code	05		Function Code	05	
Output Address	Hi	00	Output Address	Hi	00
	Lo	01		Lo	01
Output Value	Hi	FF	Output Value	Hi	FF
	Lo	00		Lo	00

In the Modbus request, the output value is FF00 in Hex which means to output ON; the output value is 0000 in Hex which means to output OFF. The normal response is an echo of the request, returned after the DO status has been written.

4.2.6. 06 (0x06) Write Single Register

This function code is used to write a single AO value. The normal response is an echo of the request, returned after the value has been written.

Here is an example of a request to write AO1 of ET-7026/PET-7026 to 55 FF (hex):

Request			Response		
Field Name		(Hex)	Field Name		(Hex)
MBAP Header		01	MBAP Header		01
		02			02
		00			00
		00			00
		00			00
		06			06
Unit ID		01	Unit ID		01
Function Code		06	Function Code		06
Register Address	Hi	00	Register Address	Hi	00
	Lo	01		Lo	01
Register Value	Hi	55	Register Value	Hi	55
	Lo	FF		Lo	FF

4.2.7. 15 (0x0F) Write Multiple Coils

This function code is used to write several DO to either ON or OFF.

The requested ON/OFF states are specified by the contents of the request data field. A logical '1' in a bit position of the field requests the corresponding output to be ON. A logical '0' requests it to be OFF. The normal response returns the function code, starting address, and several digital outputs to be written.

Here is an example of a request to write a series of 2 digital outputs starting at DO0:

The request data content is one byte: **02** hex (0000 00**10** binary). The binary bits correspond to the outputs in the following way:

Bit (0-7)	0	0	0	0	0	0	1	0
Output	-	-	-	-	-	-	DO1	DO0

Request			Response		
Field Name		(Hex)	Field Name		(Hex)
MBAP Header		01	MBAP Header		01
		02			02
		00			00
		00			00
		00			00
		08			06
Unit ID		01	Unit ID		01
Function Code		0F	Function Code		0F
Starting Address	Hi	00	Starting Address	Hi	00
	Lo	00		Lo	00
Quantity of Outputs	Hi	00	Quantity Value	Hi	00
	Lo	02		Lo	02
Byte Count		01			
Outputs Value	Lo	02			

4.2.8. 16 (0x10) Write Multiple Registers

This function code is used to write several AO values. The normal response returns the function code, starting address, and the number of analog outputs to be written.

Here is an example of a request to write two AO values starting at AO0:

Request			Response		
Field Name		(Hex)	Field Name		(Hex)
MBAP Header		01	MBAP Header		01
		02			02
		00			00
		00			00
		00			00
		0B			06
Unit ID		01	Unit ID		01
Function Code		10	Function Code		10
Starting Address	Hi	00	Starting Address	Hi	00
	Lo	00		Lo	00
Quantity of Registers	Hi	00	Quantity Value	Hi	00
	Lo	02		Lo	02
Byte Count		04			
Registers Value	Hi	00			
	Lo	0A			
	Hi	01			
	Lo	02			

The AO value is made up of 1 word (2 bytes). In the Modbus request, the AO0 value to be written is 000A in hexadecimal and the AO1 value to be written is 0064 in hexadecimal.

4.3. Modbus Master Simulators

In the previous section, we introduced the Modbus communication protocol. Now, we will describe how to achieve the Modbus/TCP communication between the ET-7x00/PET-7x00 module and PC-connection.

4.3.1. Modbus/TCP Client

Modbus Utility is a Modbus master simulator and test utility designed primarily to help users who want to test and simulate the Modbus protocol. Using the Modbus/TCP Client application, you can compose and send individual Modbus requests to a Modbus slave, and it can also continually poll (send read and write requests to) the slave. Subsequently, you can re-run the sequence of commands.

For each Modbus request, you specify the slave ID, function code, starting address, and quantity. You can refer to the previous section for more detailed information about the Modbus communication protocol. The software can be obtained from the website at:

www.icpdas.com/en/product/guide+Software+Development__Tools+Modbus__Tool#676 or www.icpdas.com/en/download/show.php?num=1028

The following instructions will help you to read the status of digital inputs in an ET-7026 by using the **Modbus Utility**.

Step 1: Right-click the **Modbus Utility** and select the **Run as administrator** option. Next, click the Modbus/TCP button for the ET-7000 module.

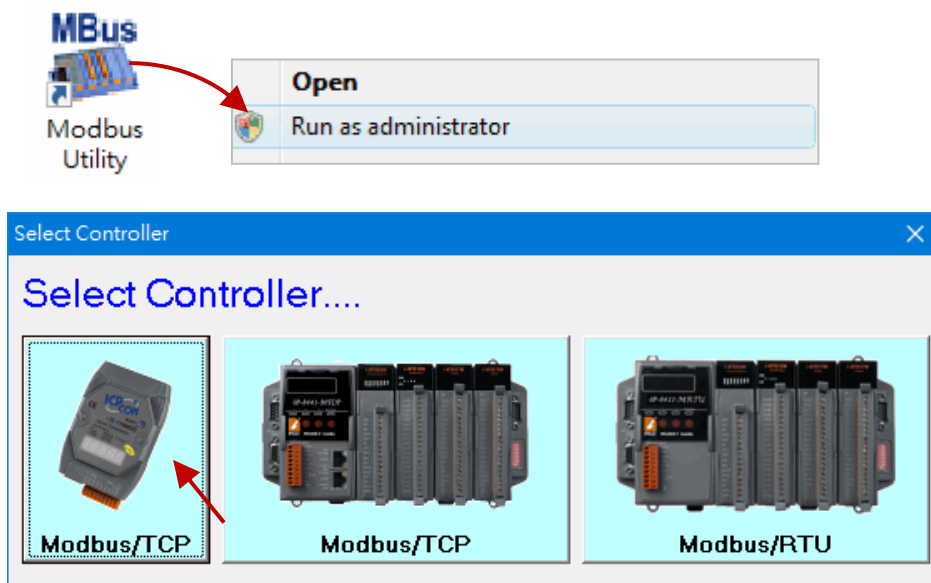

Step 2: Select the **Modbus/TCP Client** item from the **Client Tools** menu.

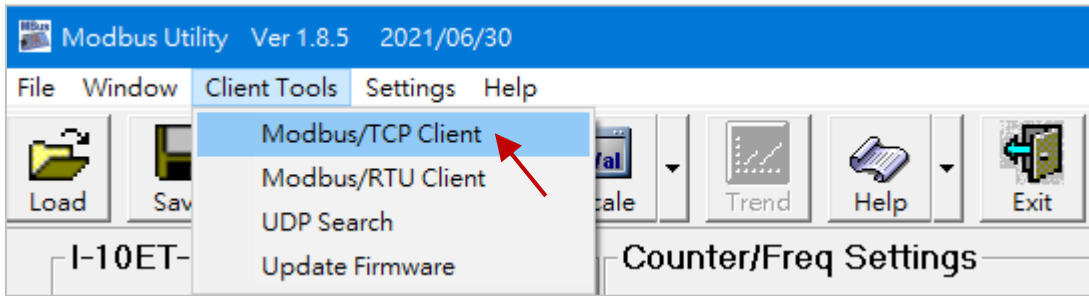

Step 3: Enter the IP address of ET-7026 in the **Modbus TCP** section and click the **“Connect”** button to connect the module.

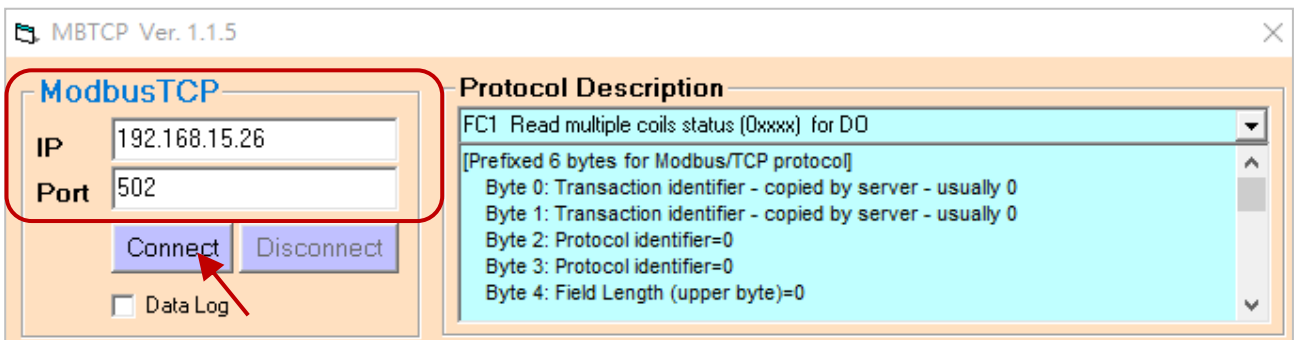

Step 4: In this case, the request is to read the status of DI0 and DI1 on ET-7026 and its Modbus ID is **“1”**. Click the **“Send Command”** button to send the Modbus request to ET-7026.

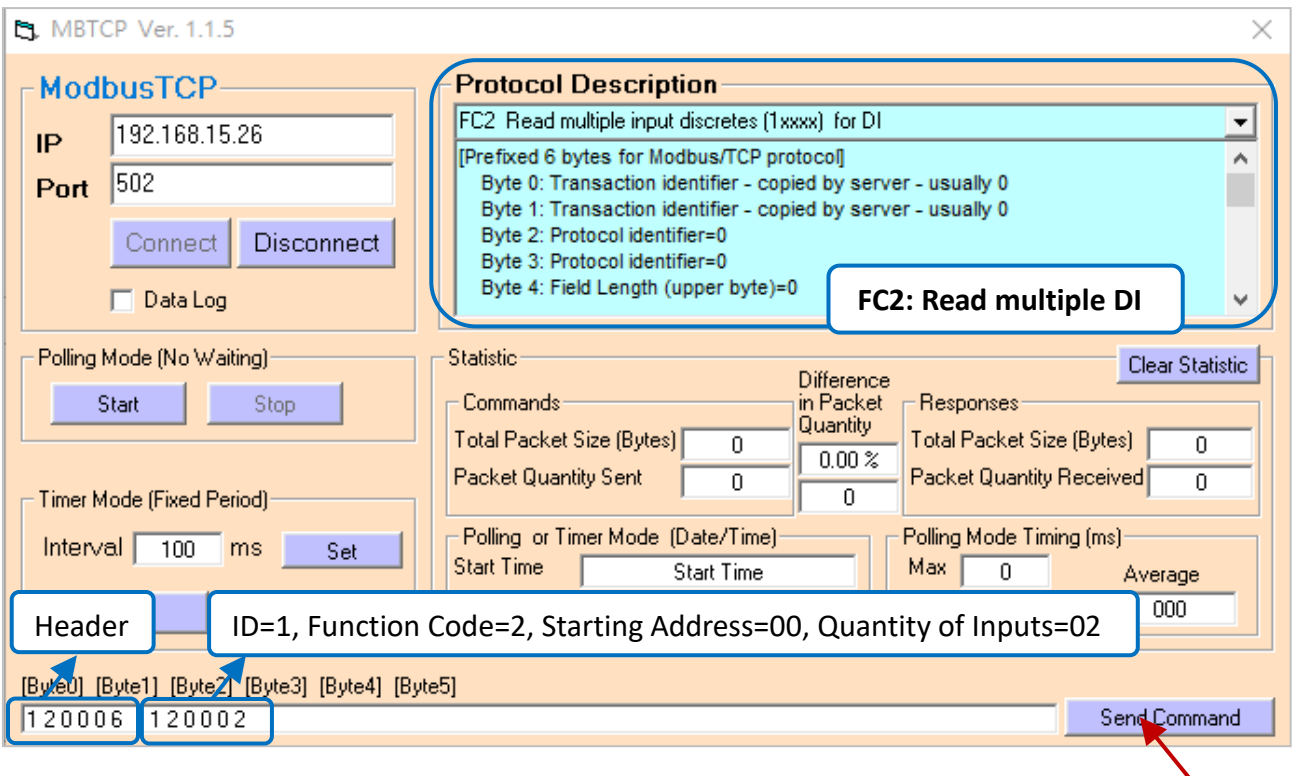

Step 5: If no error occurs, a data field of a response from the ET-7026 to the Modbus TCP Client contains the status of digital inputs of ET-7026.

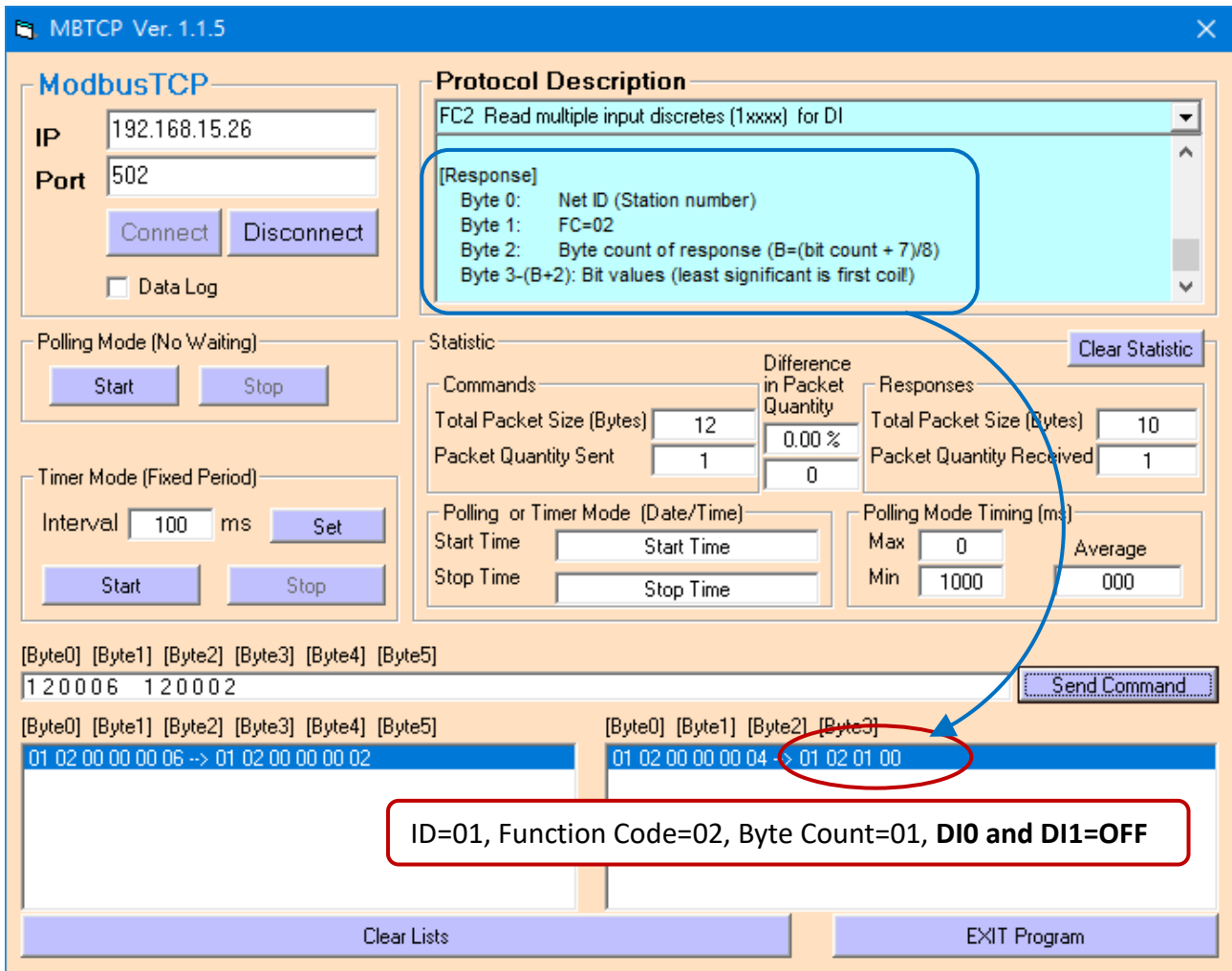

For a more detailed description of this function code, see the “**Protocol Description**” group box.

4.3.2. Modbus Master Tool

Modbus Master Tool is a Modbus master simulator designed by ICP DAS. It is used to help developers of Modbus slave devices or others that want to test the Modbus connection.

The software can be obtained from the website at:

www.icpdas.com/en/product/guide+Software+Development__Tools+Modbus__Tool#674

The following are step-by-step instructions on how to read the DO status of PET-7026.

Step 1: Double-click the “ModbusMasterToolPC.exe” to open it.

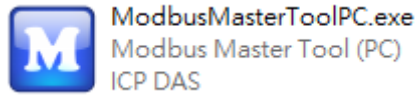

Step 2: Click the “Setup > Definition” in the menu bar to setup the parameters.

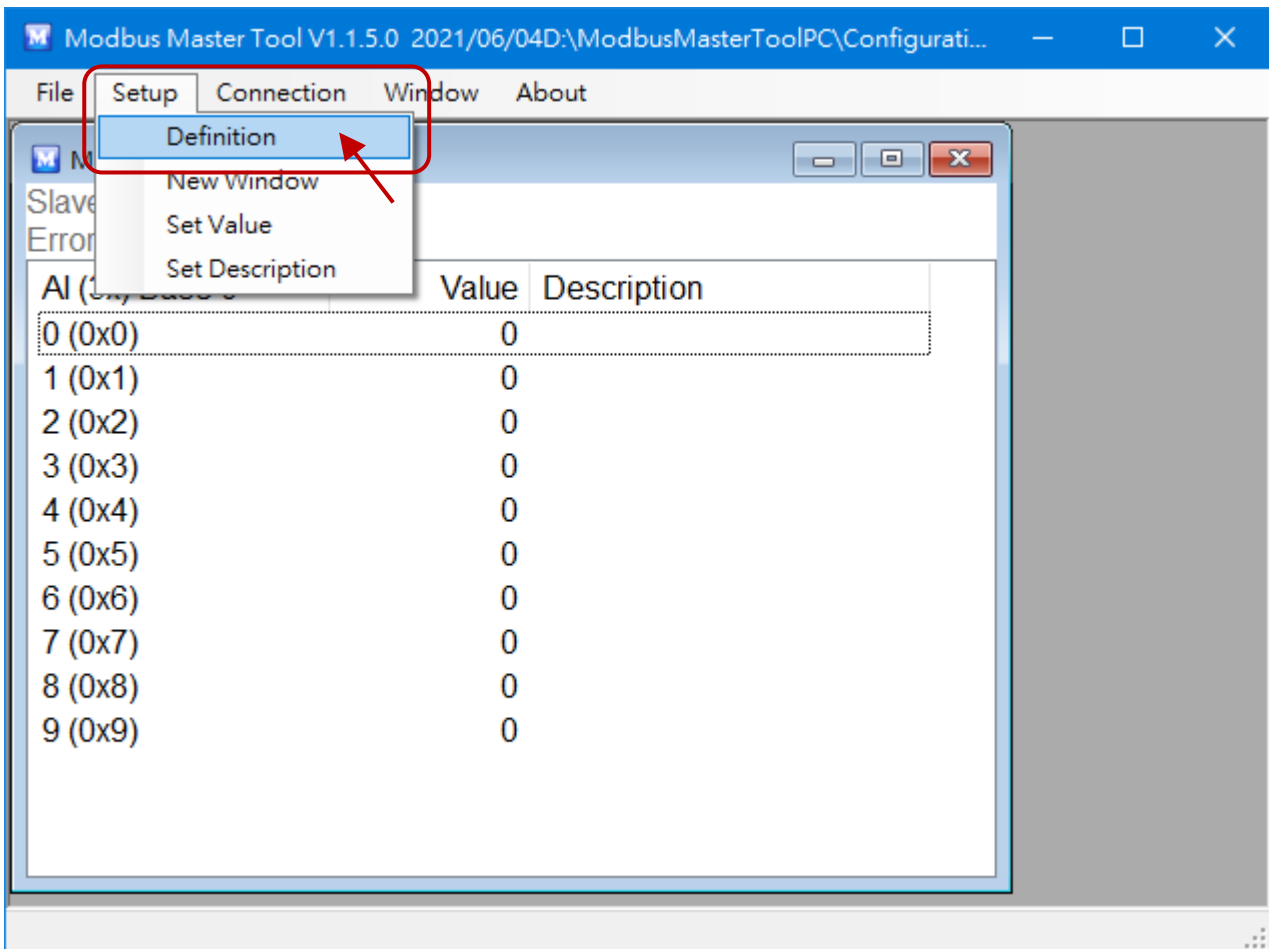

We use the same example in [section 4.5.1](#); you can see the parameters in the table.

Step	Request	
	Data Field	(Hex)
1	Unit Identifier	01
2	Function Code	01
3	Starting Address Hi	00
	Starting Address Lo	00
4	Quantity of Outputs Hi	00
	Quantity of Outputs Lo	02

You can go to “Modules I/O Settings” (section 3.2.3) to check/set the ID.

01 (0x01) Read Coils

Starting from D00

Read two channels

Definition

Slave ID: 1

Type: Read Coils Status (0xxxx) for DO

Addresses: Base 0 Base 1

Address: 0

Length: 2 00000 to 00001

Format: Singed Int16

Descriptions Clear All Descriptions

OK Cancel

Tips & Warnings



When reading or writing the AO or AI channel, select the “Hex” options in the “Format” drop-up menu.

Step 3: Click the “Connection > Connect” to set TCP Connection.

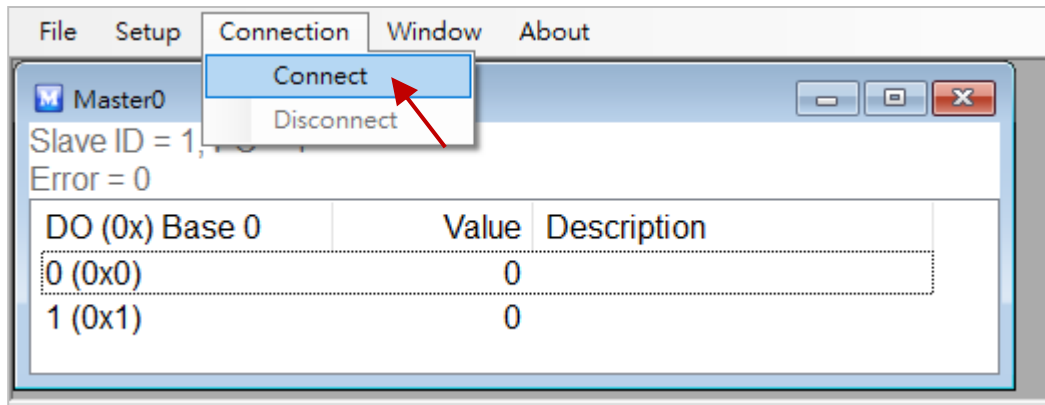

1. Select “TCP/IP” in the “Interface” field.
2. Fill out the PET-7026’s IP address in the “Remote Server IP”.
3. You can keep the settings of other fields or change them then click OK.

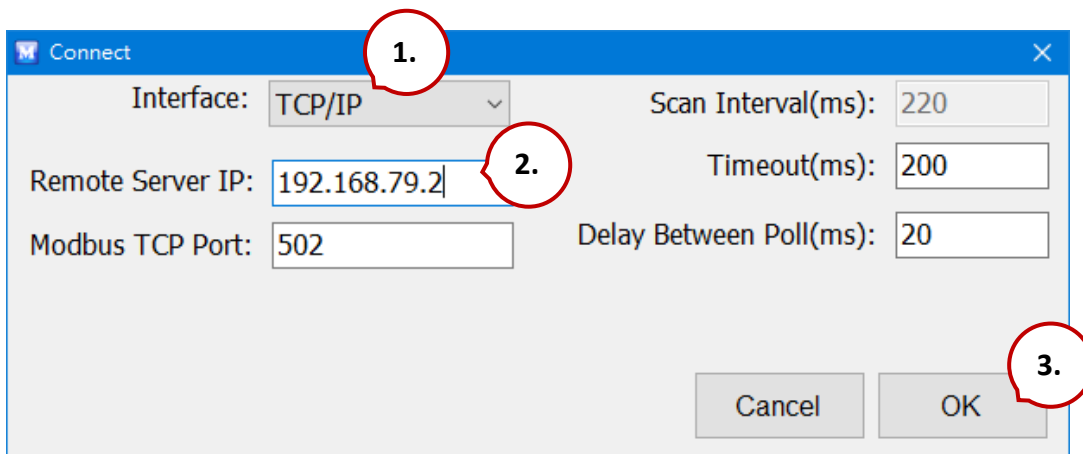

Now, the DO status of PET-7026 will show on the screen. (1: ON; 0: OFF)

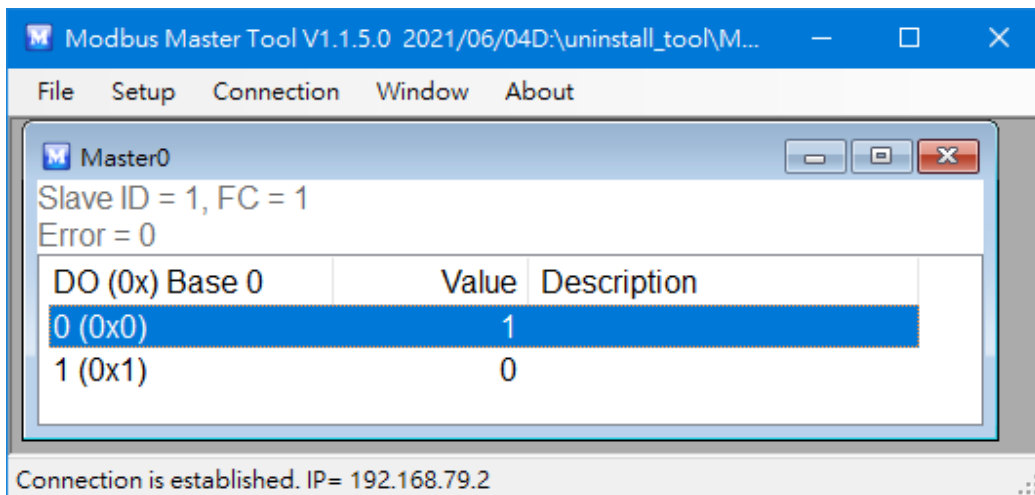

4.4. Modbus Demo Programs

nModbus is a C# 3.0 implementation of the Modbus protocol. It is developed and maintained voluntarily and provided free of charge.

The DLL based on the official releases from <http://nmodbus.googlecode.com> was verified and improved. Programmers can use the DLL released to develop a Modbus application for regular Windows-based PCs.

The relevant Modbus demo and SDK can be obtained from the following ICP DAS website.

- Documents, DLL, and Demo:

<https://www.icpdas.com/en/download/index.php?root=&model=&kw=nModbus>

Chapter 5. Calibration

Tips & Warnings



It is not recommended that calibration be performed until the process is fully understood.

5.1. Voltage and Current Calibration

Analog Input Calibration Requirement for ET-7x00/PET-7x00

Connect the calibration voltage/current source to channel 0 and only channel 0 should be enabled during calibration.

Type Code

The following table shows all of the type codes for use in voltage and current, you can use it upon the model number of ET-7x00/PET-7x00 (e.g. ET-7017 can use type 07 ~ 1A).

Type Code	00	01	02	03	04
Zero Input	0 mV	0 mV	0 mV	0 mV	0 V
Span Input	+15 mV	+50 mV	+100 mV	+500 mV	+1 V

Type Code	05	06	07	08	09
Zero Input	0 V	0 mA	0mA	0 V	0 V
Span Input	+2.5 V	+20 mA	+20 mA	+10V	+5 V

Type Code	0A	0B	0C	0D	1A
Zero Input	0 V	0 mV	0 mV	0 mA	0 mA
Span Input	+1 V	+500 mV	+150 mV	+20 mA	+20 mA

The following steps will show you how to calibrate the ET-7017 (8 AI, 4 DO):

Step 1: Warm up the module for 30 minutes.

Step 2: Enable channel 0 to calibrate and disable other channels.

Go to the configuration page of Modules I/O Settings, and set AI0 as ON and the others as OFF.

Step 3: Set the type code to the type you want to calibrate.

Select the AI range (e.g. 09, -5V ~ 5V) then click the "Submit" button.

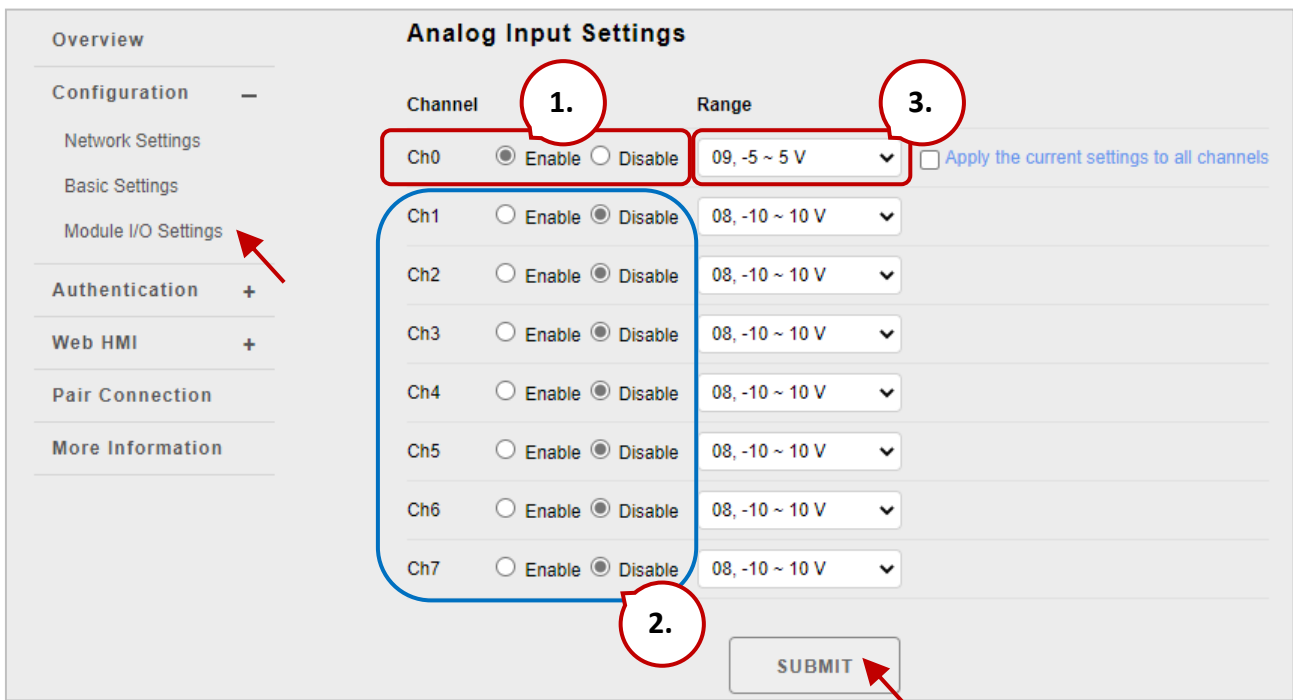

Step 4: Enable calibration.

We will complete steps 4 to 8 by using Modbus Master Tool.

Modbus Master Tool can be obtained from the ICP DAS FTP site at:

https://www.icpdas.com/en/product/guide+Software+Development__Tools+Modbus__Tool#674

4.1 Double-click the “ModbusMasterToolPC.exe” to open it and click the “**Setup > Definition**” in the menu bar to setup the parameters.

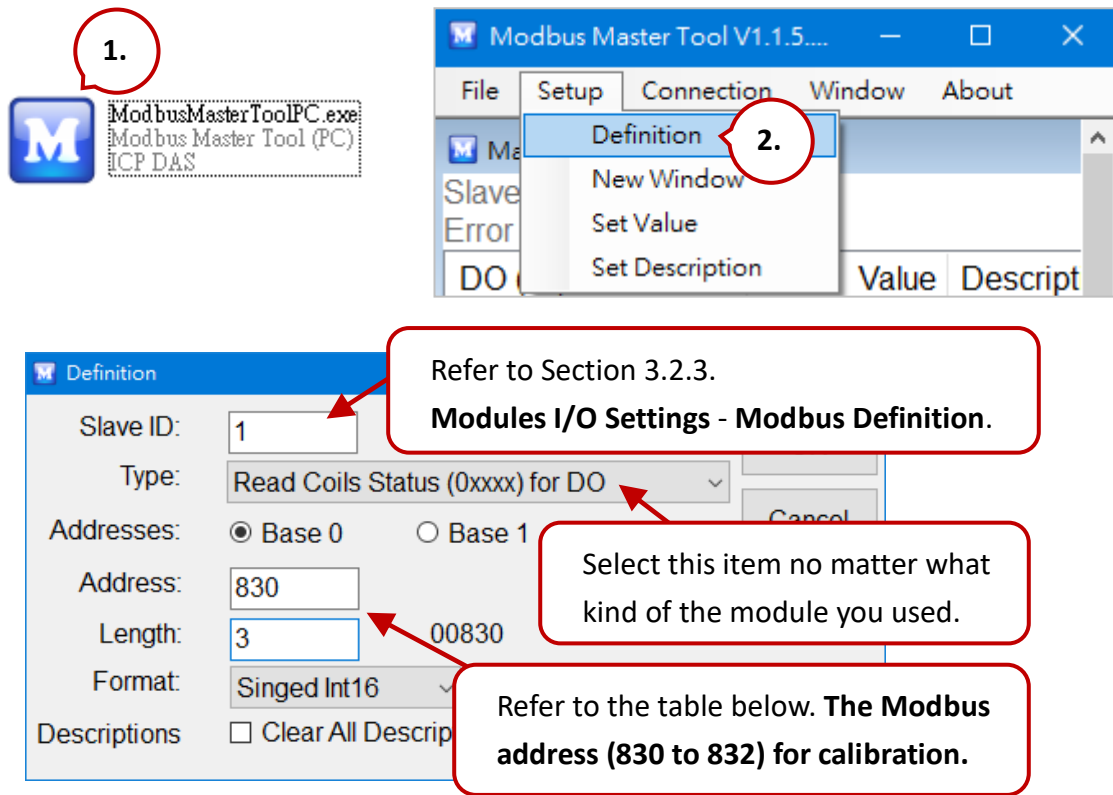

Modbus Address for Calibration

Register	Points	Description	Access Type
00830	1	Enable/Disable Calibration 0=Disabled 1=Enabled	R/W
00831	1	Zero calibration command of ch0 (1 = run)	W (Pulse)
00832	1	Span calibration command of ch0 (1 = run)	W (Pulse)

Note: When calibrating the current type (i.e. type 06, 07, and 1A), the jumper of the corresponding channel should be short.

Refer to the **ET-7x00 and PET-7x00 Register Table** for details.

<https://www.icpdas.com/en/download/show.php?num=2217>

4.2 Click the **“Connection > Connect”** in the menu bar and enter ET-7017’s IP address to establish a TCP Connection.

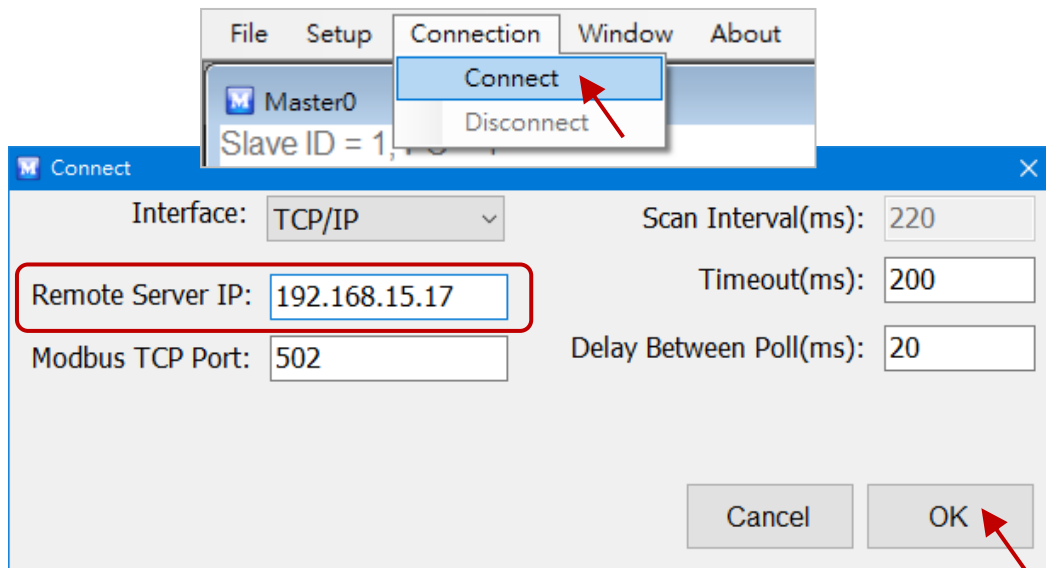

4.3 Double-click on address 830 to set it as **“ON”**. (Enable Calibration)

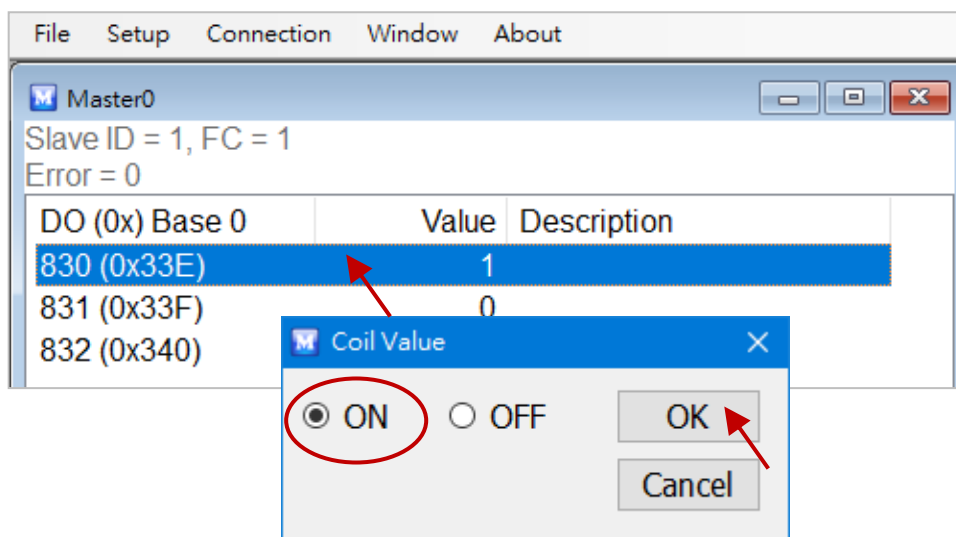

Step 5: Apply the zero calibration voltage/current to channel 0.

In this example, we use type code -09 and its “Zero Input” is 0 V.

Type Code	09
Input Range	-5V ~ +5 V

Step 6: Send the zero calibration command.

Double-click on address 831 to set it as ON. If the calibration is successful, the value will return 0.

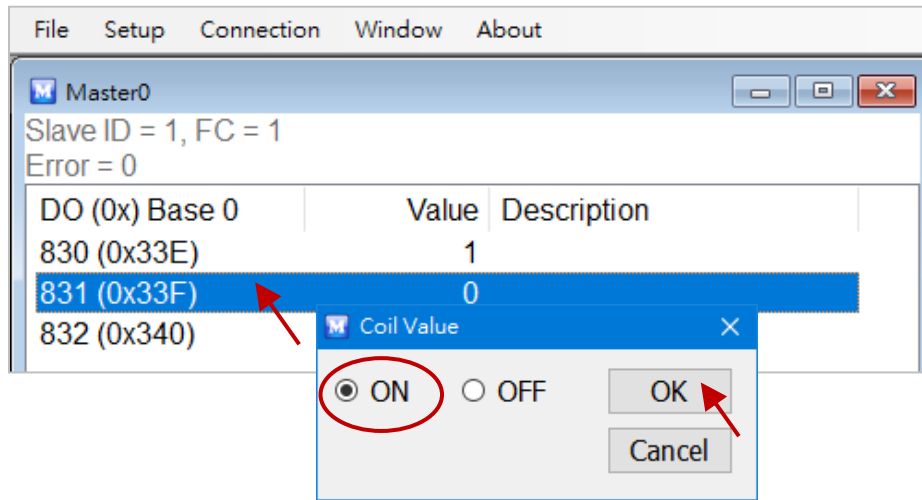

Step 7: Apply the span calibration voltage/current to channel 0.

In this example, we use type code - 09 and its “Span Input” is +5 V.

Type Code	09
Input Range	-5V ~ +5 V

Step 8: Send the span calibration command.

Double-click on address 832 to set it as ON. If the calibration is successful, the value will return 0.

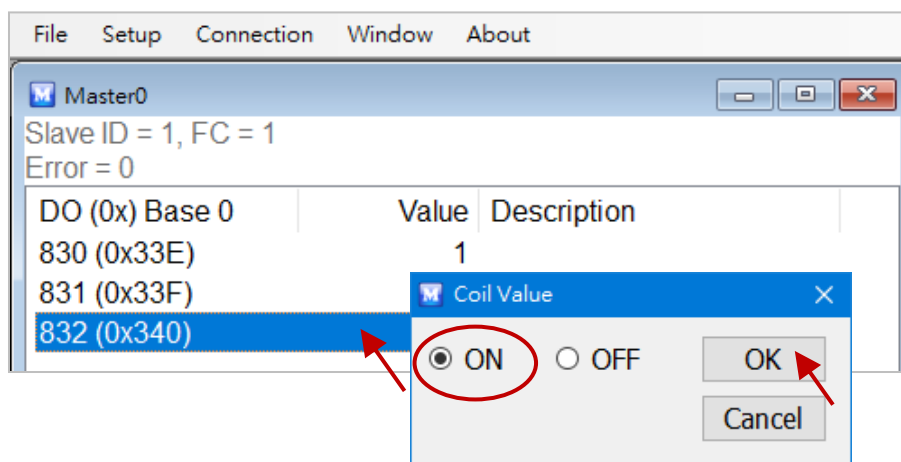

Step 9: Disable calibration.

As figure above, double-click on address 830 to set it as “OFF”.

5.2. Thermocouple Calibration

Type Code

The following table shows all of the type codes for use in the thermocouple.

Type Code	14	18	0E	10	12	13	15	16	19	0F	11	17
Thermocouple Calibration Range	00		01						02			
Zero Input	0 mV		0 mV						0 mV			
Span Input	+15 mV		+50 mV						+100 mV			

The calibration procedure is similar to section 5.1. But, the difference between them is that the ET-7x00/PET-7x00 doesn't directly support type code - **0E ~ 19** for AI calibration, so you need to change the channel 0 as a range - **00 ~ 02** to complete the work, refer to section 5.1 step 3.

- Step 1 Warm up the module for the latest 30 minutes.**
- Step 2 Set the type code to the type you wish to calibrate.**
- Step 3 Enable calibration.**
- Step 4 Apply the zero calibration voltage to channel 0.**
- Step 5 Send the zero calibration command.**
- Step 6 Apply the span calibration voltage to channel 0.**
- Step 7 Send the span calibration command.**
- Step 8 Disable calibration.**

For example

If you want to calibrate **type 0E**, you need to set the Range of channel 0 to **[01] ±50 mV**.

Modbus Settings (AI Basic Setting)

	Range (40427)	Enable (00595)
Ch0	[01] +/-50mV	OFF <input type="radio"/> ON <input checked="" type="radio"/>
Ch1	[05] +/-2.5V	OFF <input checked="" type="radio"/> ON <input type="radio"/>
Ch2	[05] +/-2.5V	OFF <input checked="" type="radio"/> ON <input type="radio"/>

5.3. RTD Calibration

Type Code

The following table shows all of the type codes for use in RTD calibration.

Type Code	20 ~ 29	2E	2F	80	81	83	2B	2C	82	2A	2D
Zero Calibration Resistor	0 Ω						0 Ω			0 Ω	
Span Calibration Resistor	375 Ω						200 Ω			3200 Ω	

Modbus Address for Calibration

Register	Points	Description	Access Type
00830	1	Enable/Disable Calibration 0=Disabled 1=Enabled	R/W
00831	1	Zero calibration command of ch0 (1=run)	W (Pulse)
00832	1	Span calibration command of ch0 (1=run)	W (Pulse)
00833	1	Zero calibration command of ch1 (1=run)	W (Pulse)
00834	1	Span calibration command of ch1 (1=run)	W (Pulse)
00835	1	Zero calibration command of ch2 (1=run)	W (Pulse)
00836	1	Span calibration command of ch2 (1=run)	W (Pulse)
00837	1	Zero calibration command of ch3 (1=run)	W (Pulse)
00838	1	Span calibration command of ch3 (1=run)	W (Pulse)
00839	1	Zero calibration command of ch4 (1=run)	W (Pulse)
00840	1	Span calibration command of ch4 (1=run)	W (Pulse)
00841	1	Zero calibration command of ch5 (1=run)	W (Pulse)
00842	1	Span calibration command of ch5 (1=run)	W (Pulse)

The calibration procedure is similar to section 5.1. However, the RTD calibration required an external resistor and must be calibrated for each channel rather than just the ch0 we mentioned before.

The calibration procedure is as follows:

- Step 1 Warm up the module for the latest 30 minutes.**
- Step 2 Set the type code to the type you wish to calibrate.**
- Step 3 Enable calibration.**
- Step 4 Connect the zero calibration resistor.**
(Refer to the table – Type Code)
- Step 5 Send the zero calibration command.**
(Refer to the table - Modbus Address for Calibration)
- Step 6 Connect the span calibration resistor.**
(Refer to the table – Type Code)
- Step 7 Send the span calibration command.**
(Refer to the table - Modbus Address for Calibration)
- Step 8 Disable calibration.**

5.4. Recover Calibration to the Factory Setting

In the **Modules I/O Settings – Analog Input Settings** configuration page, click the **"Restore Analog Calibration to Factory Settings"** item and click the **Submit** button to complete the function.

Analog Input Settings

Channel	Enable/Disable	Range	
Ch0	<input checked="" type="radio"/> Enable <input type="radio"/> Disable	09, -5 ~ 5 V	<input type="checkbox"/> Apply the current settings to all channels
Ch1	<input type="radio"/> Enable <input checked="" type="radio"/> Disable	08, -10 ~ 10 V	
Ch2	<input type="radio"/> Enable <input checked="" type="radio"/> Disable	08, -10 ~ 10 V	
Ch3	<input type="radio"/> Enable <input checked="" type="radio"/> Disable	08, -10 ~ 10 V	
Ch4	<input type="radio"/> Enable <input checked="" type="radio"/> Disable	08, -10 ~ 10 V	
Ch5	<input type="radio"/> Enable <input checked="" type="radio"/> Disable	08, -10 ~ 10 V	
Ch6	<input type="radio"/> Enable <input checked="" type="radio"/> Disable	08, -10 ~ 10 V	
Ch7	<input type="radio"/> Enable <input checked="" type="radio"/> Disable	08, -10 ~ 10 V	

SUBMIT

Modbus Address	Function	Options
00628	Normal Mode (10 Hz)/Fast Mode (50 Hz)	<input checked="" type="radio"/> Normal mode <input type="radio"/> Fast mode
00629	60/50 Hz Rejection	<input checked="" type="radio"/> 60 Hz <input type="radio"/> 50 Hz
00631	Data Format	<input checked="" type="radio"/> HEX 2's complement <input type="radio"/> Engineering
00632	Restore Analog Calibration to Factory Settings	<input checked="" type="checkbox"/>

SUBMIT

Chapter 6. MiniOS7 Utility Tools

MiniOS7 Utility is a tool for uploading firmware to flash memory and updating the OS to ET-7x00/PET-7x00 module embedded with MiniOS7 with easiness and quickness.

If you haven't the MiniOS7 Utility installed on your system, installation of the MiniOS7 Utility should be the first step. Please refer to section "2.4 Installing MiniOS7 Utility" to install it.

6.1. Establishing a Connection

To upload firmware or update the OS to ET-7x00/PET-7x00 module, you must first establish a connection between the PC and the ET-7x00/PET-7x00 module.

Step 1: Run the MiniOS7 Utility

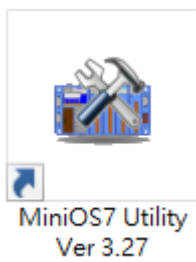

Double-click the "MiniOS7 Utility" shortcut on your desktop.

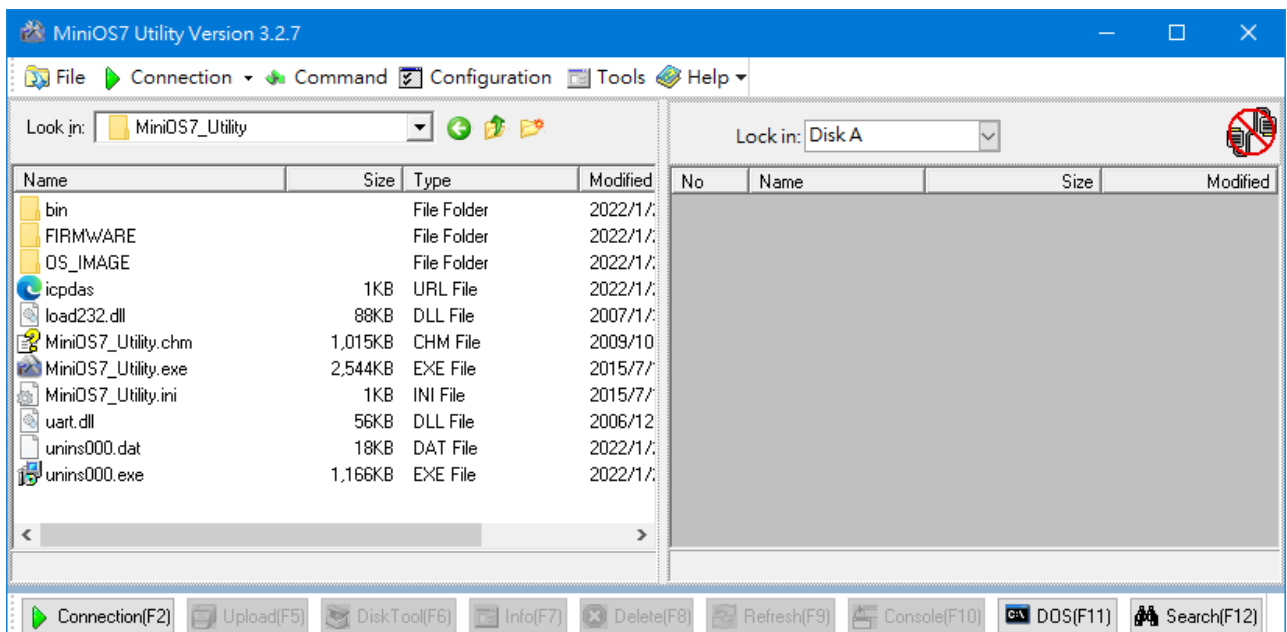

Step 2: Press the “F12” key or choose the “Search” option from the “Connection” menu

After pressing the “F12” key or choosing the “Search” option from the “Connection” menu, the MiniOS7 utility performs a search of all modules on your network.

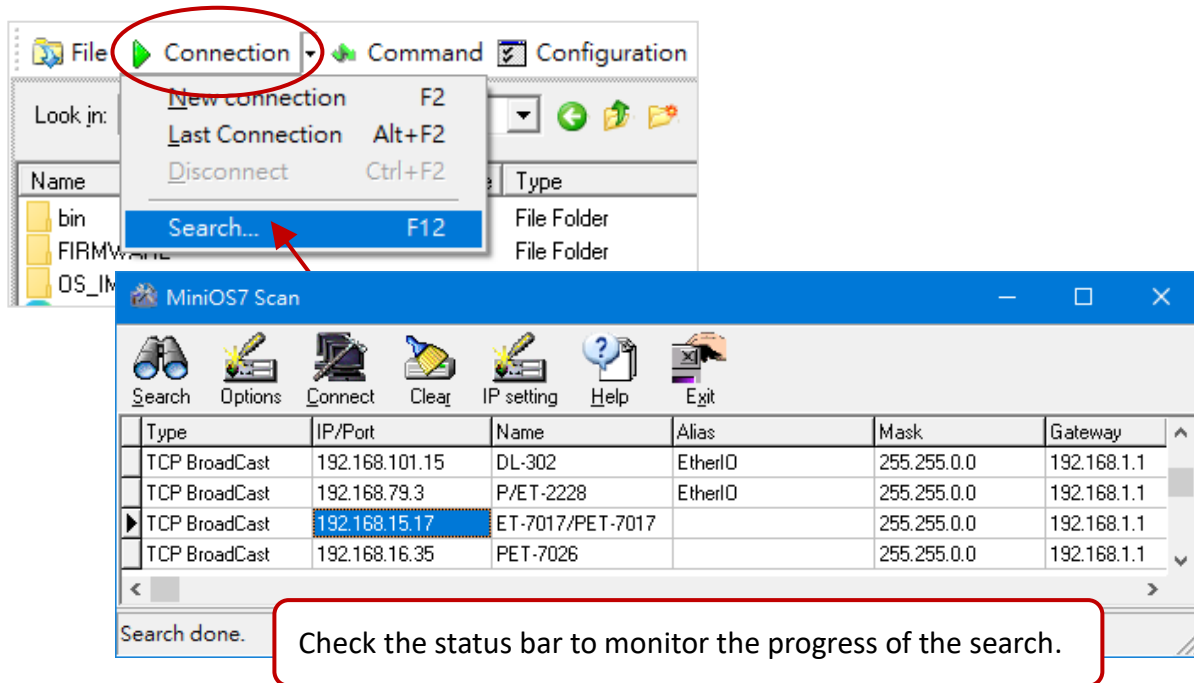

Step 3: Click the IP address in the IP/Port field list and then click the “Connect” icon in the toolbar

After the search has been completed, click the IP address for the ET-7x00/PET-7x00 module in the IP/Port field list and then click the “Connect” icon in the toolbar to connect to the ET-7x00/PET-7x00.

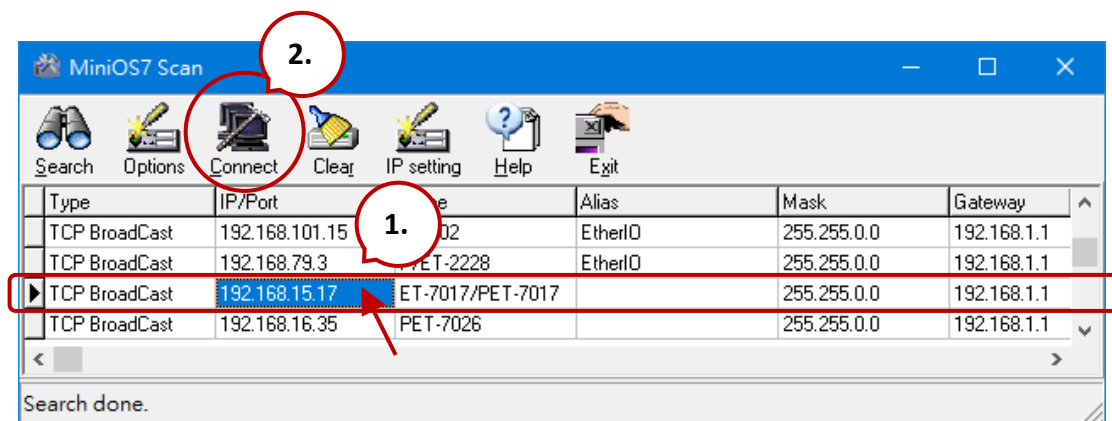

Step 4: Check the connection symbol to make sure that the connection is established

A connection symbol is displayed on the top right side of the screen to make sure the connection has been established.

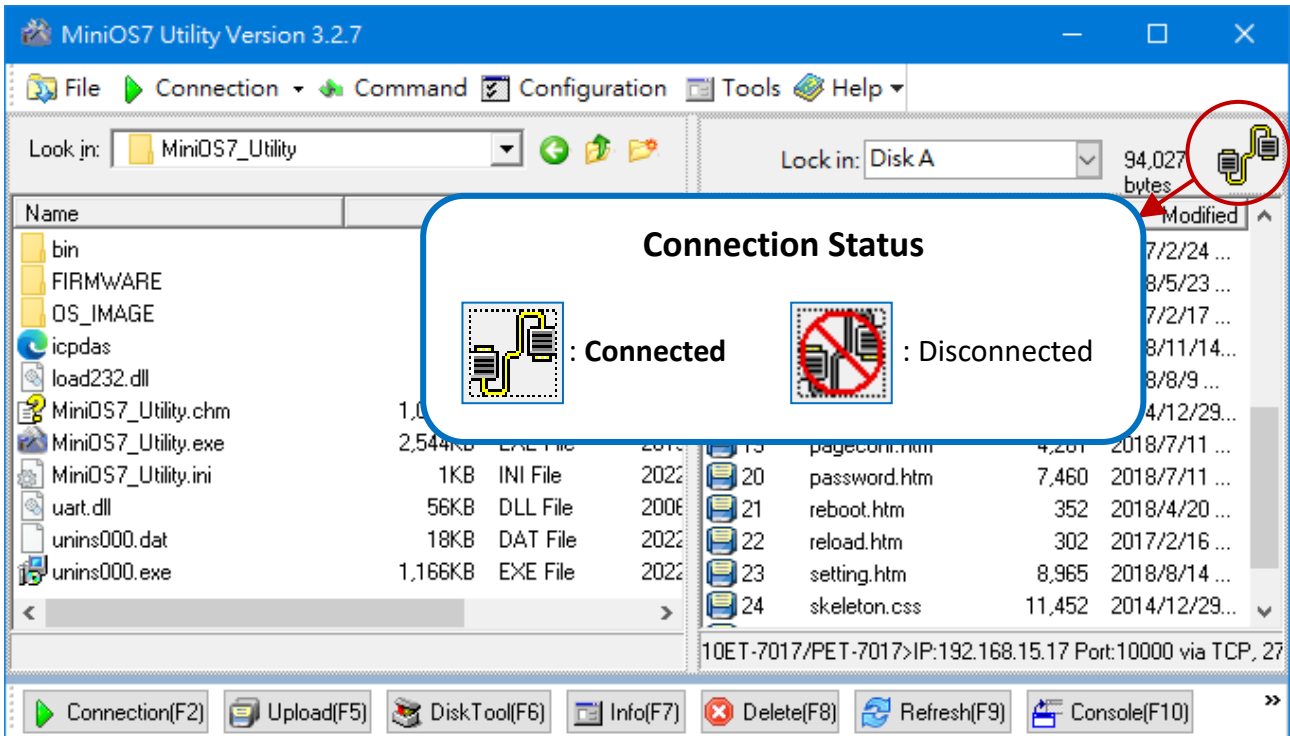

6.2. Exchanging the Protocol (TCP/IP to UDP)

MiniOS7 Utility supports both UDP and TCP protocols. For MiniOS7 Utility, the TCP/IP is the default protocol for communicating with ET-7x00/PET-7x00, and the UDP is used to update the OS. **Changing the protocol to UDP if you want to update the OS.**

Step 1: Establish a connection to the ET-7x00/PET-7x00

For more information, refer to section “6.1. Establishing a Connection”.

Step 2: Stop running the firmware

Right-click the file list of the right side windows, and then choose “Quit Firmware” to stop the firmware running and exchange TCP/IP protocol to UDP protocol.

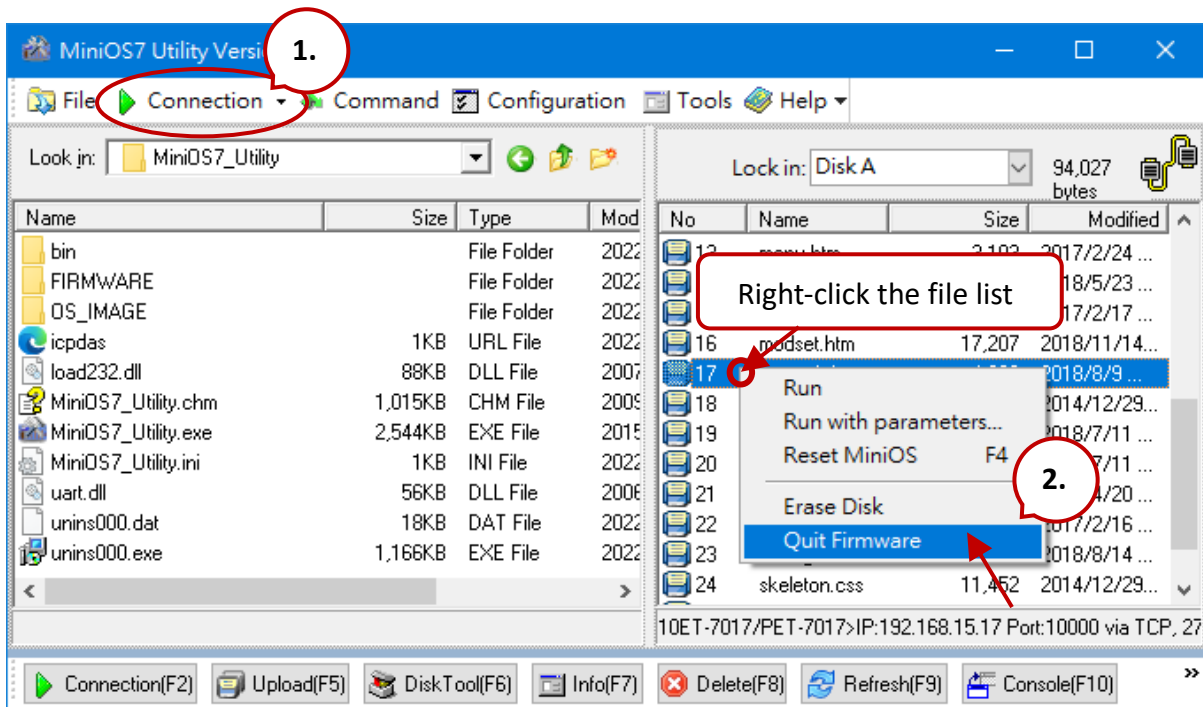

Step 3: Click the “Yes” button to continue and the settings will take effect

After executing the Quick Firmware command, the “Confirm” dialog will appear, and then click the “Yes” button to continue and stop the firmware running.

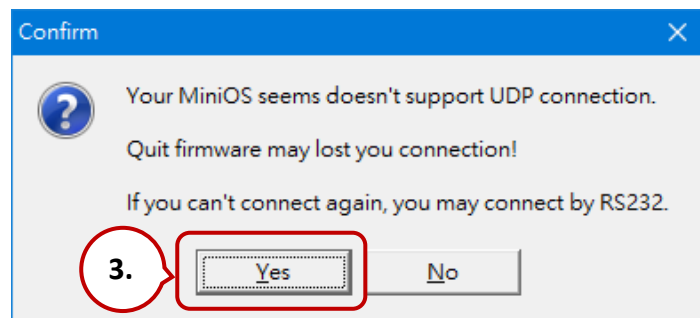

6.3. Updating the OS

Additional features to ET-7x00/PET-7x00 OS will continue to be added in the future, so we advise you to periodically check with the ICP DAS website for the latest updates.

6.3.1. Using the MiniOS7 Utility

Step 1: Download the latest version of the MiniOS7 OS image

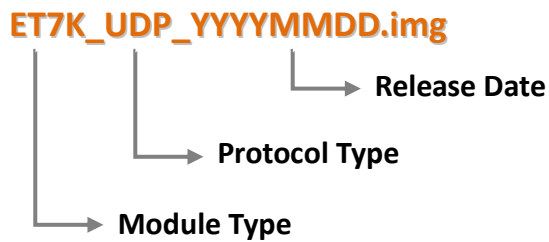

For ET-7000/PET-7000 series module:

The latest version of the MiniOS7 OS image can be obtained from the ICP DAS website at:

<https://www.icpdas.com/en/download/show.php?num=2235>

For ET-7200/PET-7200 series module:

The latest version of the MiniOS7 OS image can be obtained from the ICP DAS website at:

<https://www.icpdas.com/en/download/show.php?num=2236>

Step 2: Be sure that the switch is set to the "Init" position and then reboot the module

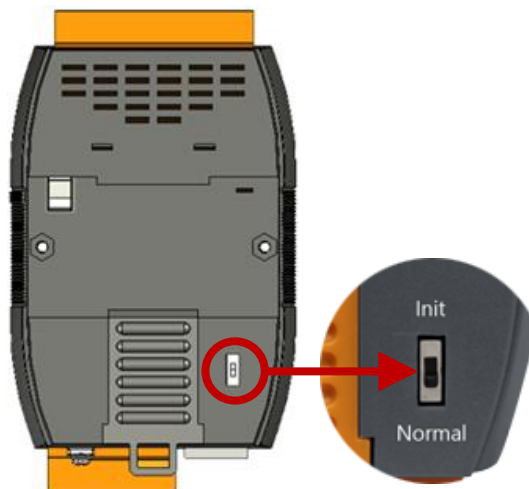

Step 3: Establish a connection to ET-7x00/PET-7x00

Refer to section “6.1. Establishing a Connection & 6.2 Exchange the protocol”. Waiting for a while to search available **UDP** devices.

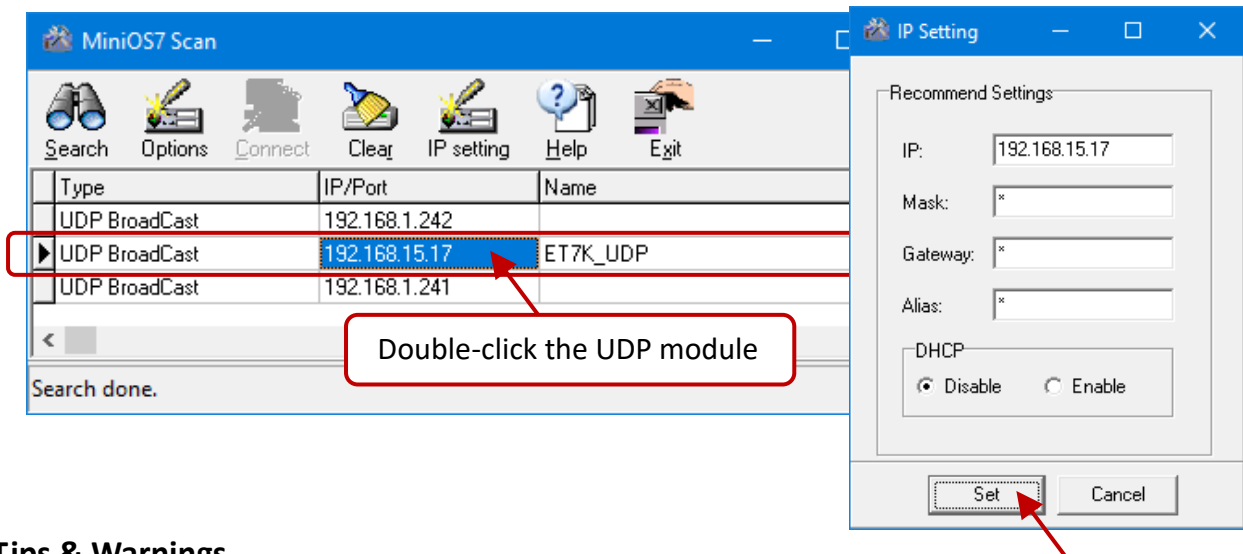

Tips & Warnings

If the connection fails, it is recommended to click the “**Options**” from the “**Configuration**” menu to change the “**Response Timeout**” setting (e.g., 1200 ms).

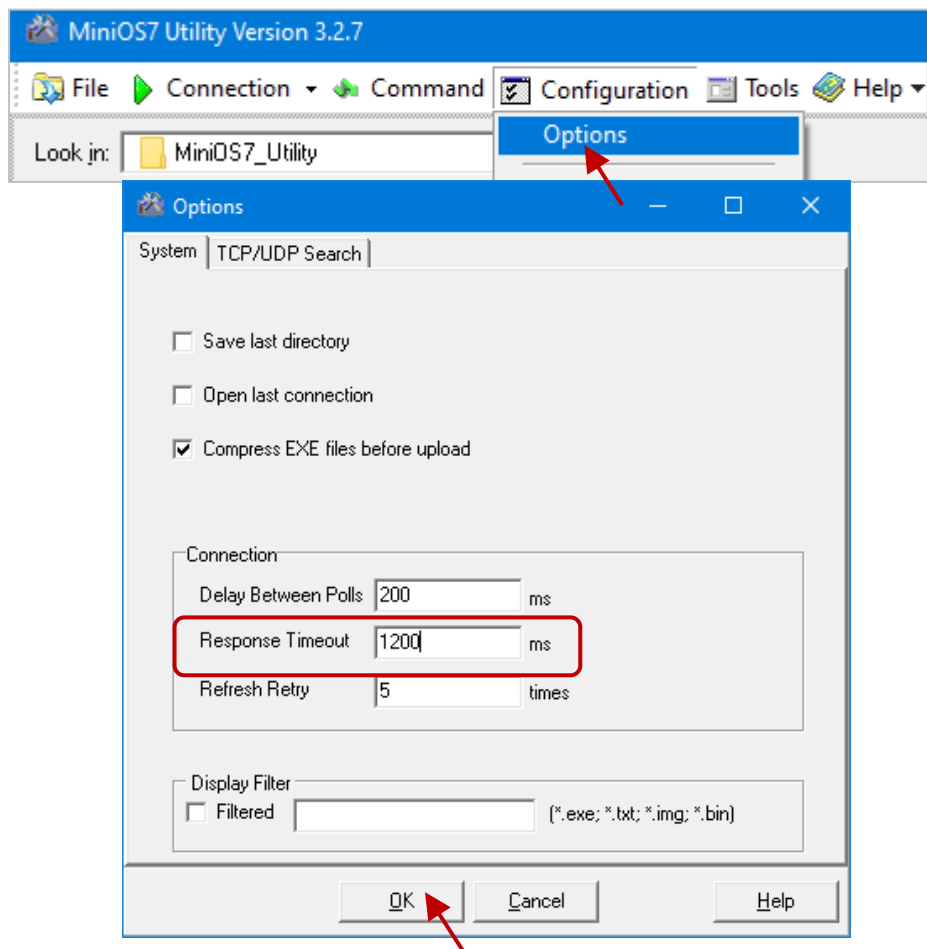

Step 4: Choose “Update MiniOS7 Image” from the “File” menu

Choose “Update MiniOS7 Image” from the File menu to start the update procedure.

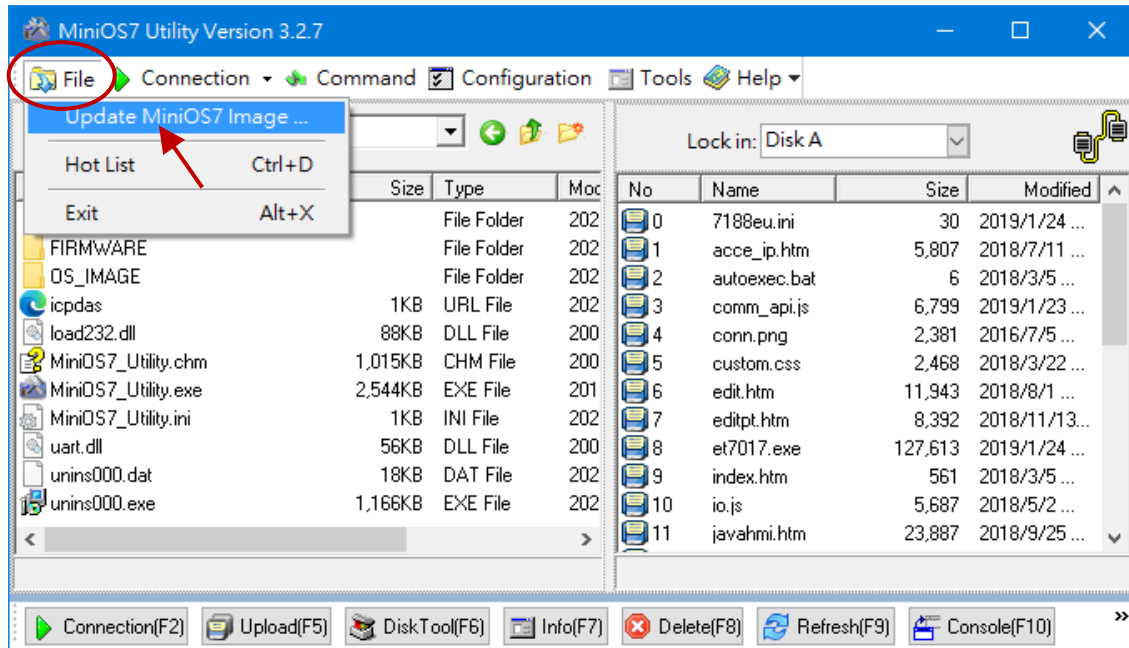

Step 5: Select the latest version of the MiniOS7 OS image

After choosing the update MiniOS7 Image command, the “Select MiniOS7 Image file” dialog will appear, and then select the latest version of the MiniOS7 OS image. Note that DO NOT update the same version as the current one.

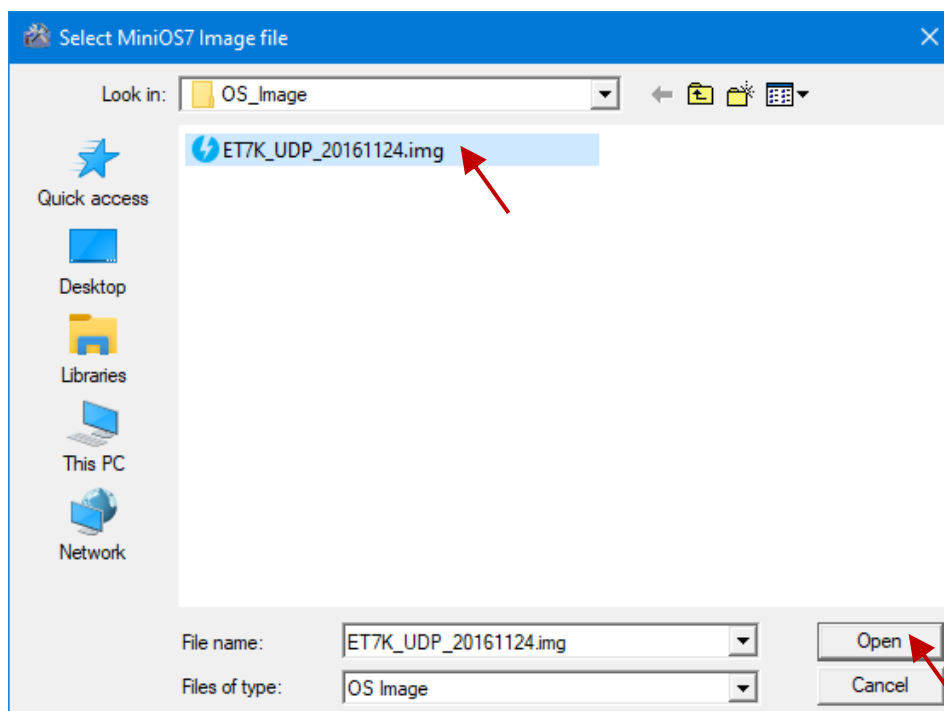

Step 6: Click “OK” to finish the procedure

After confirming the command, you just need to wait a while until the following dialog appears, and then click the “OK” button to finish the procedure.

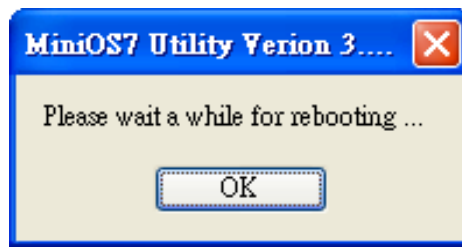

Step 7: To check the OS version

After pressing “F7” or choosing “info” from the “Command” menu, check the OS version of the “Build” entry.

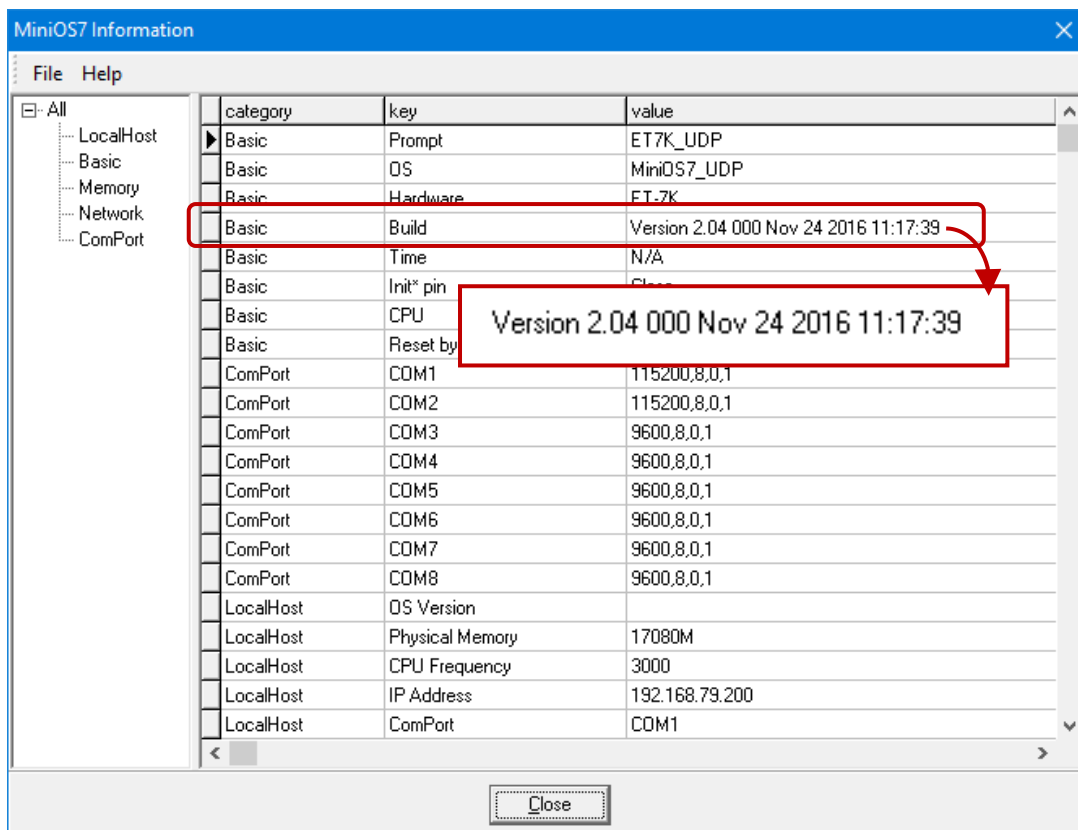
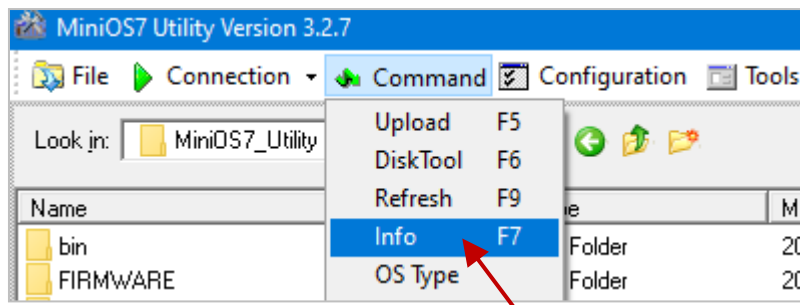

6.3.2. Using the 7188EU.exe and Command Line

Note: If you cannot update OS successfully, use the method of the command line instead.

Step 1: Be sure that the switch is set to the “Init” position and then reboot the module

It is necessary to update the MinisOS7 image under the INIT mode, adjust the switch to INIT on the back of the module, and reboot.

Step 2: Run the MiniOS7 Utility and the file folder of the MinisOS7 image.

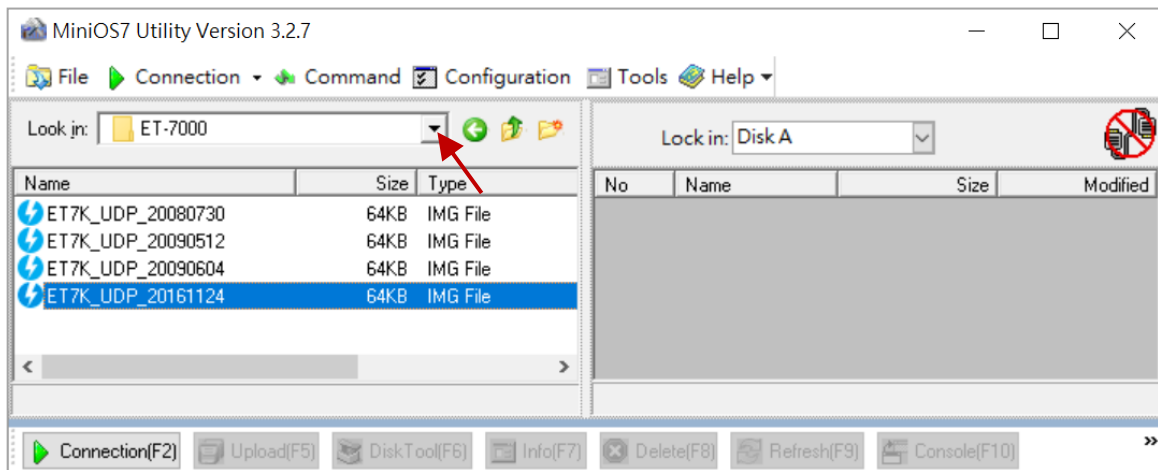

Step 3: Connect to the module by using UDP

Click **Tools > 7188EU** on the menu bar and enter “/s: IP address of the module /p:23” in the “Parameters” dialog.

Description of parameters:

/s:192.168.255.1 → IP address of the module

/p:23 → UDP Port 23 (fixed)

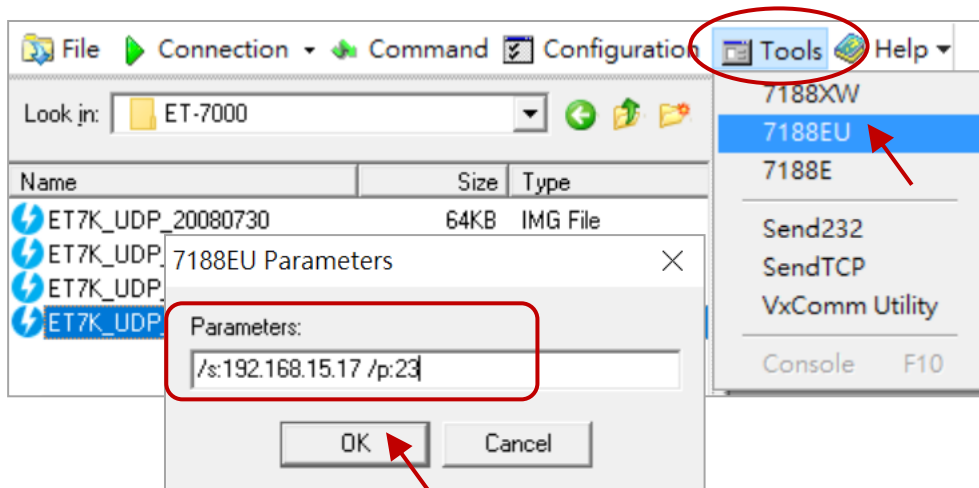

Step 4: Upload the MiniOS7 image

Press Enter to see “ET7K_UDP>” in the window and input the **upload** command, then press Enter. Also, press **ALT + E** and enter the full name of the image file (e.g., ET7K_UDP_20161124.img)

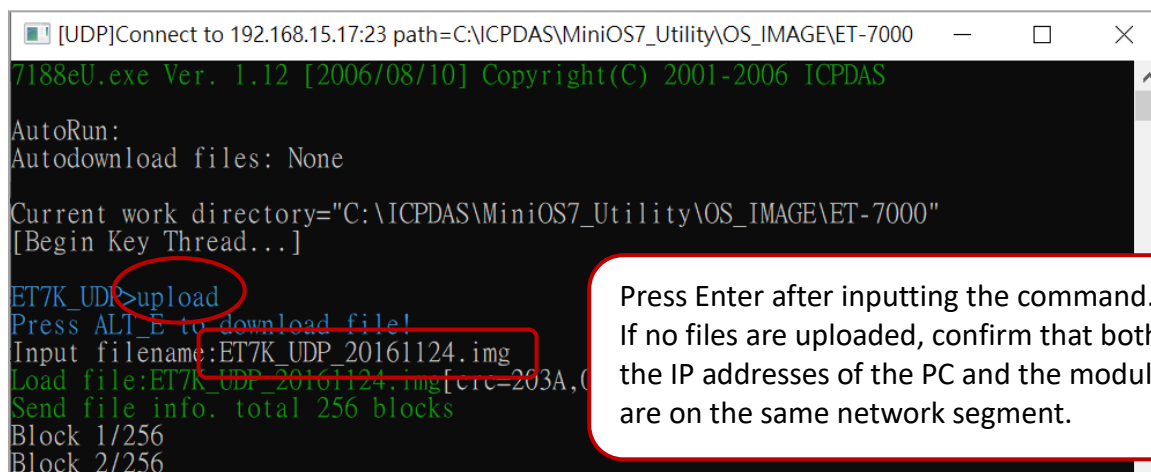

```
[UDP]Connect to 192.168.15.17:23 path=C:\ICPDAS\MiniOS7_Utility\OS_IMAGE\ET-7000
7188eU.exe Ver. 1.12 [2006/08/10] Copyright(C) 2001-2006 ICPDAS
AutoRun:
Autodownload files: None
Current work directory="C:\ICPDAS\MiniOS7_Utility\OS_IMAGE\ET-7000"
[Begin Key Thread...]
ET7K_UDP>upload
Press ALT_E to download file!
Input filename:ET7K_UDP_20161124.img
Load file:ET7K_UDP_20161124.img[crc=203A,0
Send file info. total 256 blocks
Block 1/256
Block 2/256
```

Press Enter after inputting the command. If no files are uploaded, confirm that both the IP addresses of the PC and the module are on the same network segment.

Step 5: Update the OS image file to a Flash

Enter the **bios1** command to update the image to the flash. It spends 15 seconds for updating and does not perform power off or reboot.

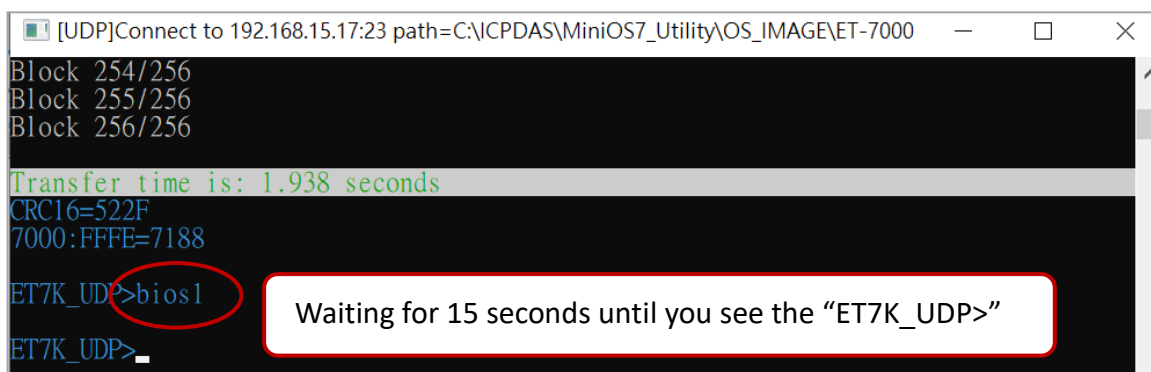

```
Block 254/256
Block 255/256
Block 256/256
Transfer time is: 1.938 seconds
CRC16=522F
7000:FFFE=7188
ET7K_UDP>bios1
ET7K_UDP>
```

Waiting for 15 seconds until you see the “ET7K_UDP>”

Step 6: Confirm the version of the MiniOS7 by using the “ver” command

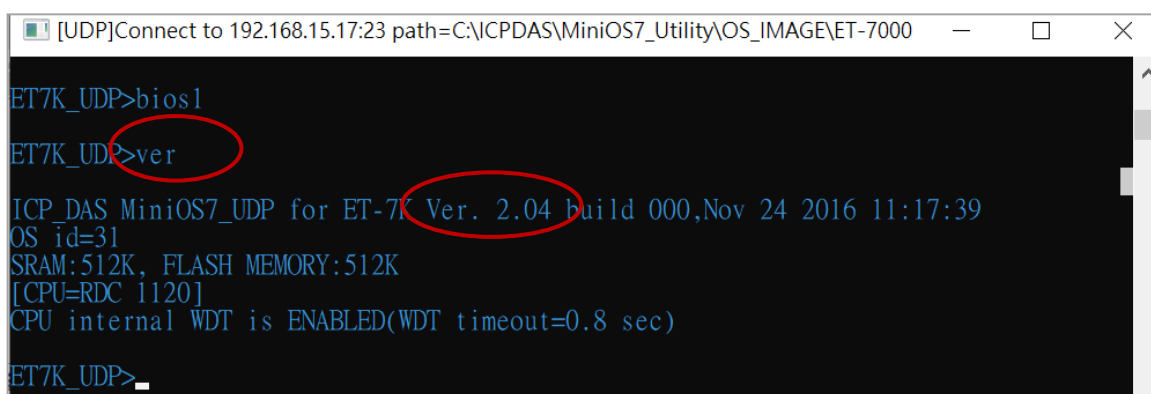

```
ET7K_UDP>bios1
ET7K_UDP>ver
ICP_DAS MiniOS7_UDP for ET-7K Ver. 2.04 build 000,Nov 24 2016 11:17:39
OS id=31
SRAM:512K, FLASH MEMORY:512K
[CPU=RDC 1120]
CPU internal WDT is ENABLED(WDT timeout=0.8 sec)
ET7K_UDP>
```

6.4. Updating the Firmware

The firmware is stored in flash memory and can be updated to fix functionality issues or add additional features, so we advise you to periodically check the ICP DAS website for the latest updates.

Download the latest version of the firmware:

ET-7x00, PET-7x00

The latest version of the ET-7000/PET-7000 firmware can be obtained from:

<https://www.icpdas.com/en/download/show.php?num=3790>

ET-7200, PET-7200

The latest version of the ET-7200/PET-7200 firmware can be obtained from:

V1:

<https://www.icpdas.com/en/download/show.php?num=3785>

V2:

<https://www.icpdas.com/en/download/show.php?num=2233>

6.4.1. Using the MiniOS7 Utility

Step 1: Be sure that the switch is set to the “Init” position and then reboot the module

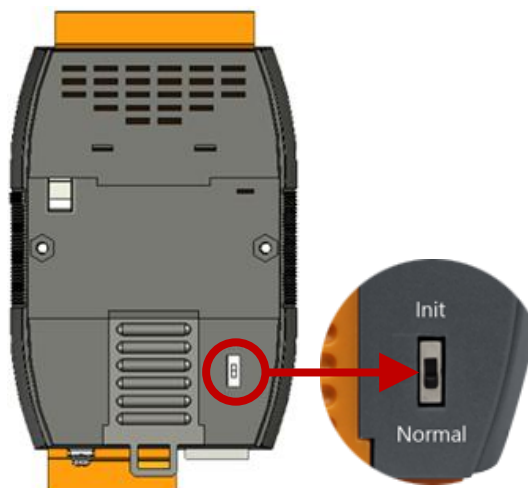

Step 2: Establish a connection to connect to the ET-7x00/PET-7x00

For a more detailed description of this instruction, refer to section “6.1. Establishing a Connection”.

Tips & Warnings



If the connection fails, it is recommended to click the “**Options**” from the “**Configuration**” menu to change the “**Response Timeout**” setting (e.g., 1200 ms).

You have to delete all files that existed on the ET-7x00/PET-7x00 before uploading the firmware.

Step 3: Choose “Erase Disk” from the “Command” menu

After establishing a connection, then choose “**Erase Disk**” from the “**Command**” menu (or right-click on the right of the window) to erase the contents of the flash memory.

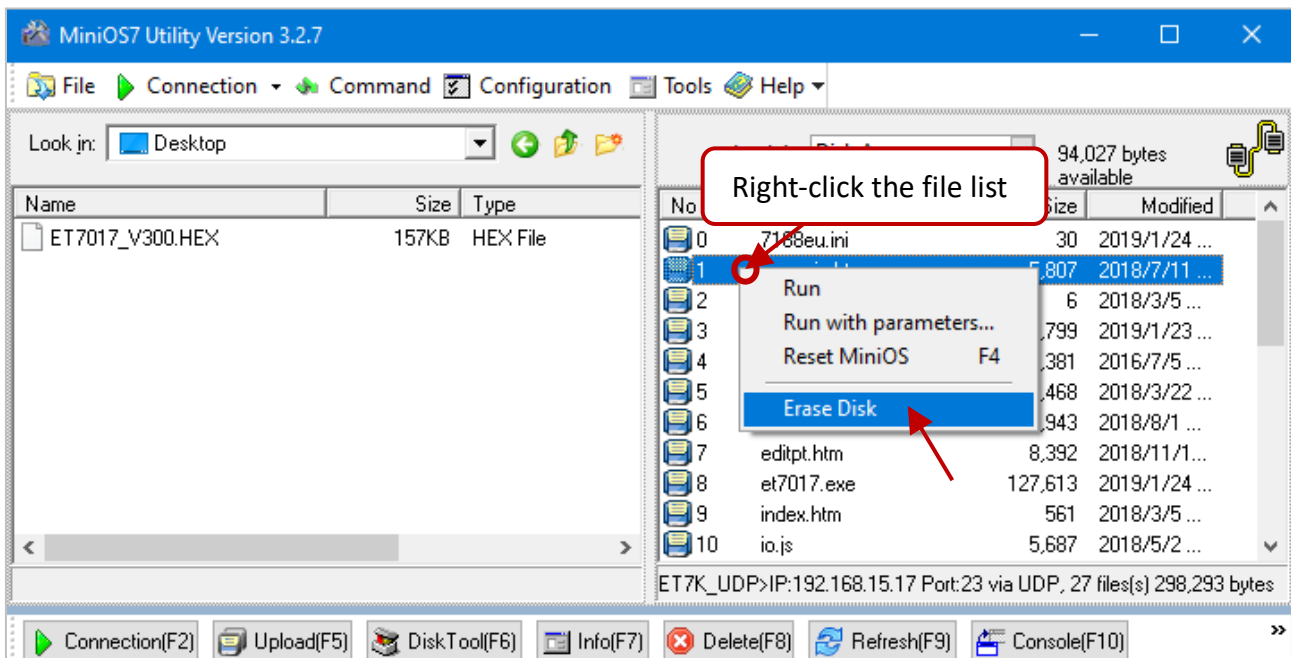

Step 4: In the Confirm dialog box, click the “Yes” button to continue.

After executing the Erase Disk command, the **Confirm** dialog will appear, and then click the “**Yes**” button to continue erasing the memory contents.

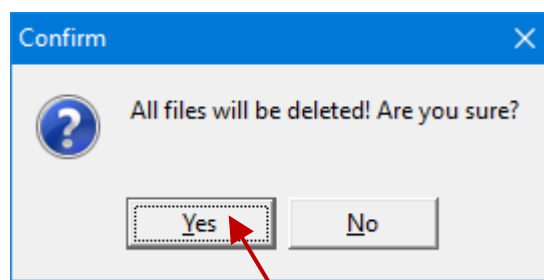

Step 5: Select the latest version of the firmware.

Select the new version of the firmware and click the **Upload(F5)** button to upload the file to ET-7x00/PET-7x00.

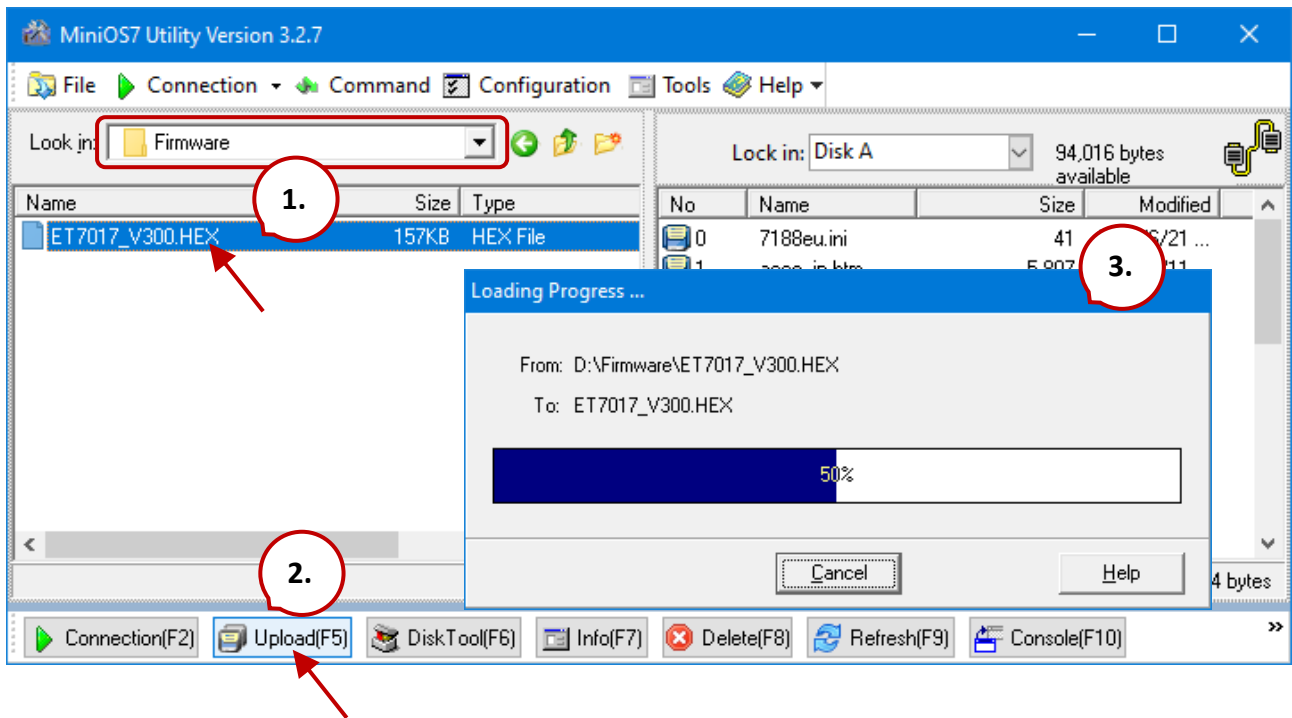

Step 6: After the update is complete, set the switch on the back of the module to the "Normal" position and reboot.

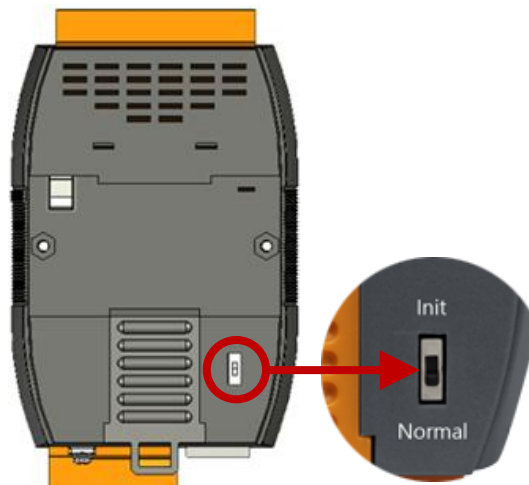

6.4.2. Using the eSearch Utility

Download and install the **eSearch Utility**:

https://www.icpdas.com/en/product/guide+Software+Utility_Driver+eSearch__Utility

Step 1: Run the **eSearch utility** and click on the **Search Server** button to find the ET-7000 module.

Step 2: Right-click on the module name and select **Firmware Update**.

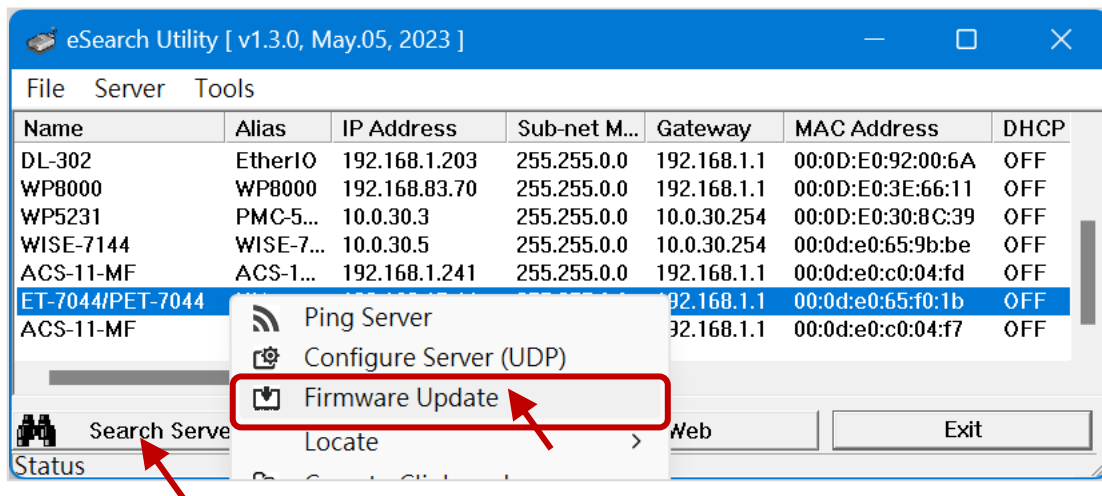

Step 3: Select the firmware file and click on the **Open** button.

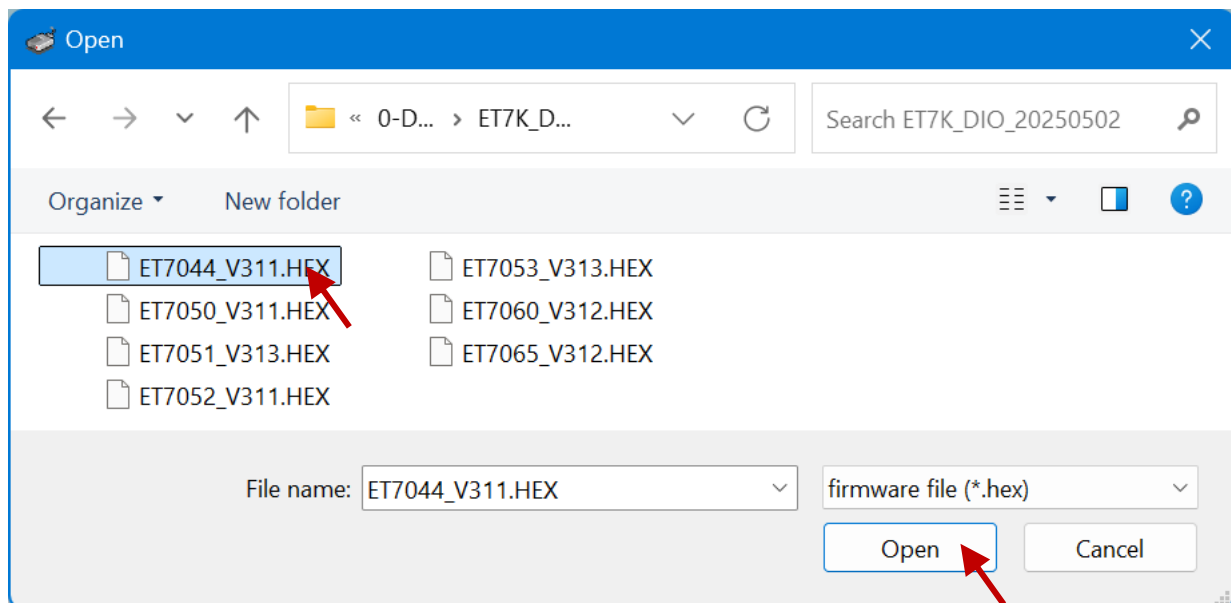

Step 4: Make sure the IP address and MAC address are correct. Click on the OK button.

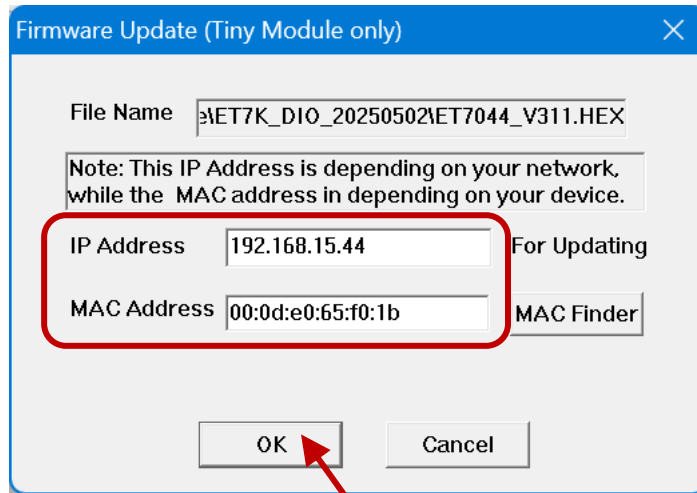

Step 5: The progress (e.g., 30%) will be shown in the status bar. After completion, the module will automatically reboot. Click the “Web” button to log in to the configuration page and check the firmware version.

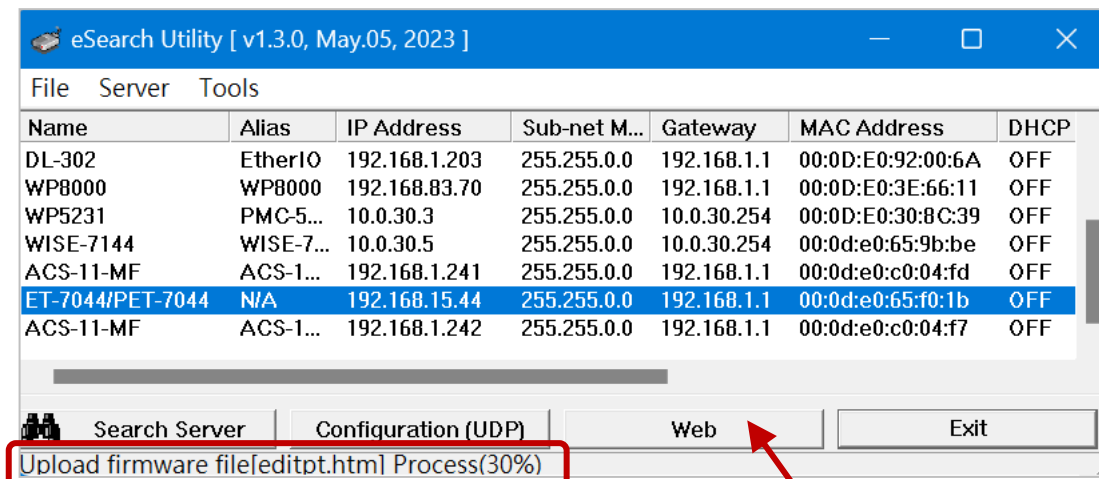

Overview	<h1>ET-7044 / PET-7044</h1> <p>An Ethernet module that is equipped with 8 digital outputs, 8 digital inputs and 8 counters.</p>	
Configuration	Module Information:	
Authentication	MAC Address: 00:0D:E0:65:F0:1B	
Web HMI	Firmware Version: 3.1.1 (May 02, 2025)	
Pair Connection	I/O Version: 3.08	
Maintenance	Ethernet Version: 1.29 (Feb. 25, 2019)	
More Information	Web Server Version: 2.10.5 (Jun. 03, 2024)	
Logout	OS Version: 2.4.0 (Nov. 24, 2016)	

Chapter 7. SCADA and System Integration Tools

ET-7x00/PET-7x00 supports several external tools to aid in developing your applications

7.1. LabVIEW

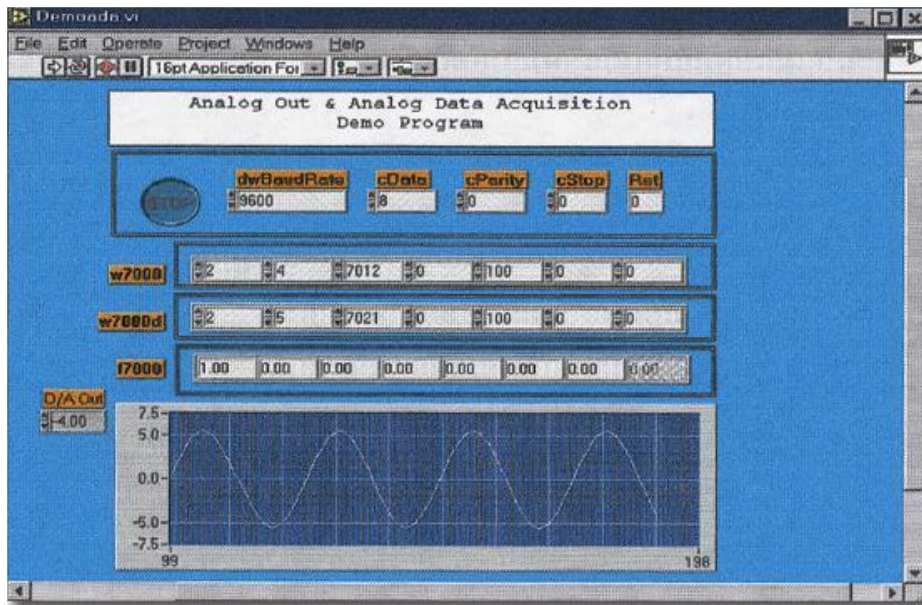

LabVIEW is the best way to acquire, analyze, and present data. LabVIEW delivers a graphical development environment that can be used to quickly build data acquisition, instrumentation, and control systems, boosting productivity and saving development time. With LabVIEW, it is possible to quickly create user interfaces that enable interactive control of software systems. To specify your system functionality, simply assemble a block diagram – a natural design notation for scientists and engineers.

The document containing the detailed instructions for linking to the ET-7x00/PET-7x00 using the Modbus protocol is located at

<https://www.icpdas.com/en/download/show.php?num=1029>

7.2. OPC Server

OPC (OLE for Process Control) is the first standard resulting from the collaboration of several leading worldwide automation suppliers working in cooperation with Microsoft. Originally based on Microsoft's OLE COM (Component Object Model) and DCOM (Distributed Component Object Model) technologies, the specification defines a standard set of objects, interfaces, and methods for use in process control and manufacturing automation applications to facilitate interoperability.

There are many different mechanisms provided by various vendors that allow access to a variety of devices via specific applications. However, if an OPC Server is provided for the device, other applications will be able to access the OPC Server via the OPC interface.

7.3. SCADA

SCADA stands for Supervisor Control and Data Acquisition. It is a production automation and control system based on PCs.

SCADA is widely used in many fields e.g. power generation, water systems, the oil industry, chemistry, and the automobile industry. Different fields require different functions, but they all have common features:

- Graphic interface
- Process mimicking
- Real-time and historic trend data
- Alarm system
- Data acquisition and recording
- Data analysis
- Report generator

Accessing the ET-7x00/PET-7x00 module

SCADA software can access ET-7x00/PET-7x00 devices using Modbus communication protocols and can communicate without the need for other software drivers.

Famous SCADA software

Citect, ICONICS, iFIX, InduSoft, Intouch, Entivity Studio, Entivity Live, Entivity VLC, Trace Mode, Wizcon, Wonderware, etc.

In the following sections, 3 popular brands of SCADA software are introduced together with detailed instructions on how to use them to communicate with ET-7x00/PET-7x00 module using the Modbus/TCP protocol.

7.3.1. InduSoft



[InduSoft Web Studio](#) is a comprehensive platform that includes all the tools you'll need to make SCADA and HMI applications that have real power behind them. The development environment allows you to develop once and deploy anywhere.

InduSoft Web Studio supports all Windows runtime platforms (including 32 and 64-bit), ranging from Windows Embedded Compact, Windows Embedded Standard, Windows 8.1/10, and Windows Server Editions (Server 2012/2016/2019), along with built-in support for local or remote (web) based visualization.

Build powerful graphical displays and take advantage of the 250+ available communication drivers for all major PLC products. InduSoft Web Studio includes OPC UA and OPC Classic (HDA and DA), trends, alarms, reports, recipes, and built-in SQL database support as standard features.

The document containing detailed instructions for linking to the ET-7x00/PET-7x00 module using the Modbus protocol is located on

<https://www.icpdas.com/en/faq/index.php?kind=133>

7.3.2. Citect

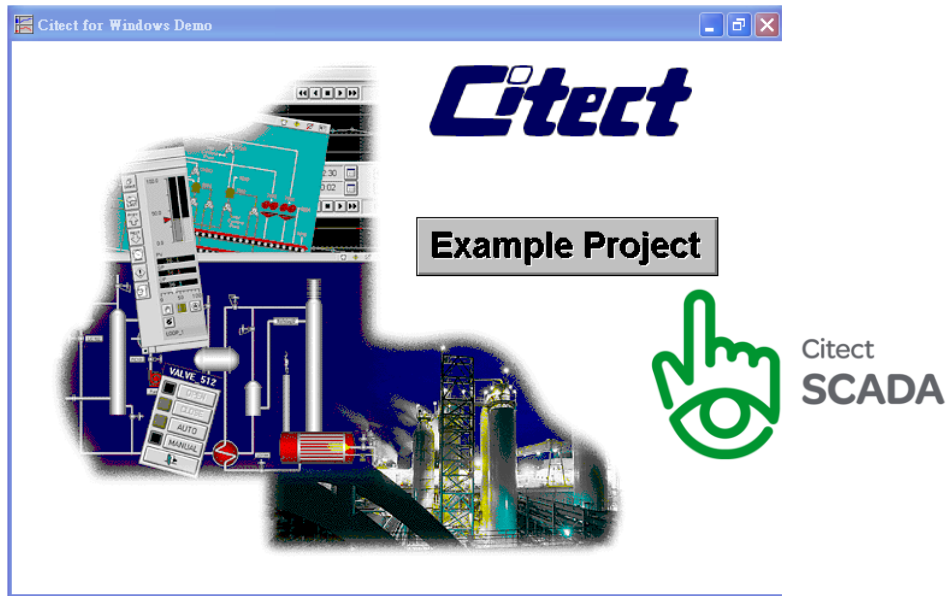

Citect SCADA is a fully integrated Human Machine Interface (HMI) / SCADA solution that enables users to increase return on assets by delivering a highly scalable, reliable control and monitoring system. Easy-to-use configuration tools and powerful features enable rapid development and deployment of solutions for any size application.

The document containing detailed instructions for linking to the ET-7x00/PET-7x00 module using the Modbus protocol is located on

<https://www.icpdas.com/en/faq/index.php?kind=133>

https://www.icpdas.com/en/product/guide+Software+Development__Tools+Modbus__Tool#1150

7.3.3. iFix



The document containing detailed instructions for linking to the ET-7x00/PET-7x00 module using the Modbus protocol is located on

<https://www.icpdas.com/en/faq/index.php?kind=133>

https://www.icpdas.com/en/product/guide+Software+Development__Tools+Modbus__Tool#1150

Appendix A Description of I/O Functions

A.1. Dual Watchdog

The Dual Watchdog consists of Module Watchdog and Host Watchdog.

1. **The Module Watchdog** is a built-in hardware circuit that will reset the CPU module if a failure occurs in either the hardware or the software. If the application does not refresh the watchdog timer within 0.8 seconds, the watchdog circuit will initiate a reset of the CPU.
2. **The Host Watchdog** is a software function that can be used to monitor the operating status of the host. Its purpose is to prevent network communication problems or host failure. If the Watchdog timeout interval expires, the module will return all outputs to a predefined Safe value (Refer to the Safe Value application note), which can prevent the controlled target from an unexpected situation.

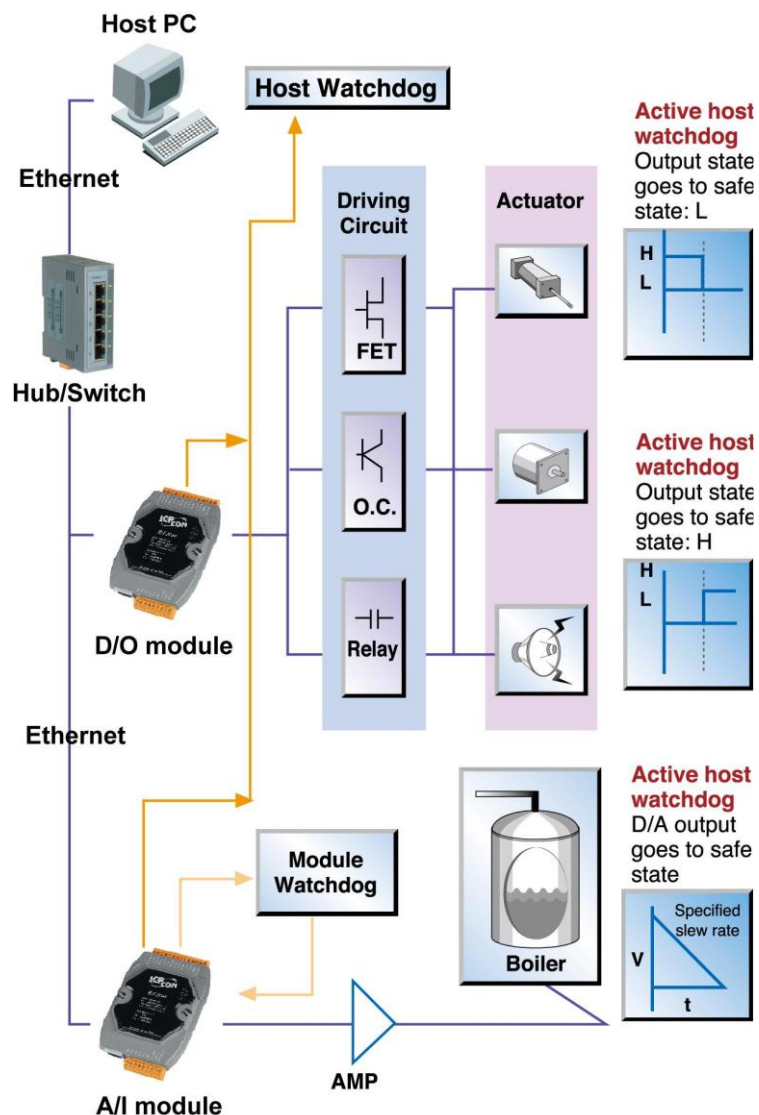

A.2. Power-on Value

Many industrial applications require a "safe" start-up condition to prevent accidents at critical points in the process. Each ET-7x00/PET-7x00 contains an initial power-on value which is used to configure the analog/digital outputs on power up. In other words, the power-on value can be considered a start-up value. The power-on value is loaded into the output modules under 3 conditions: power on, reset by Module Watchdog, and reset by the reset command.

Users can set the power-on value of the specific analog/digital output channel and the power-on value is stored in EEPROM.

Setting the Power-on Value for a Specific Digital Output Channel

Channel	Power-on Value	Value
Ch0	<input checked="" type="radio"/> On <input type="radio"/> Off	Disabled - Maintain the current status Enabled - Host Watchdog Enabled - Pair-Connection
Ch1	<input type="radio"/> On <input checked="" type="radio"/> Off	Disabled - Maintain the current status
Ch2	<input type="radio"/> On <input checked="" type="radio"/> Off	Disabled - Maintain the current status
Ch7	<input type="radio"/> On <input checked="" type="radio"/> Off	Disabled - Maintain the current status

Step 1: Log into the ET-7x00/PET-7x00 web page, and then click the "Module I/O Settings" option in the "Configuration" section of the Main Menu.

Step 2: Enable the Power-on Value by checking the "ON" radio button.

Step 3: Click the "Submit" button to complete the configuration of the power-on Value.

Setting the Power-on Value for a Specific Analog Output Channel

Overview

Configuration —

Network Settings

Basic Settings

Module I/O Settings

Authentication +

Web HMI +

Pair Connection

More Information

Analog Output Settings

Channel	Range	Slew Rate
Ch0	35, -5 ~ 5 V	00, Immediate
Ch1	35, -5 ~ 5 V	00, Immediate

Apply the current

SUBMIT

Channel	Power-on Value	Safe Value	
Ch0	0.0 -5 ~ 5 V	0.0 -5 ~ 5 V	Disabled - Maintain the current status
Ch1	0.0 -5 ~ 5 V	0.0 -5 ~ 5 V	Disabled - Maintain the current status

SUBMIT

Step 1: Log into the ET-7x00/PET-7x00 web page, and then click the “**Module I/O Settings**” option in the “**Configuration**” section of the Main Menu.

Step 2: Set the Power-on Value in the “**Power-on Value**” text box.

Step 3: Click the “**Submit**” button to complete the configuration of the Power-on Value and save the settings to the EEPROM.

A.3. Safe Value

When the Host Watchdog is enabled and the communication between the host PC and ET-7x00/PET-7x00 modules is broken, the analog/digital output channels can generate a predefined value to prevent unpredictable damage to the connected devices. By default, this feature is disabled. Users can enable this feature by configuring the Host WDT Timeout.

Setting the Safe Value for a Specific Digital Output Channel

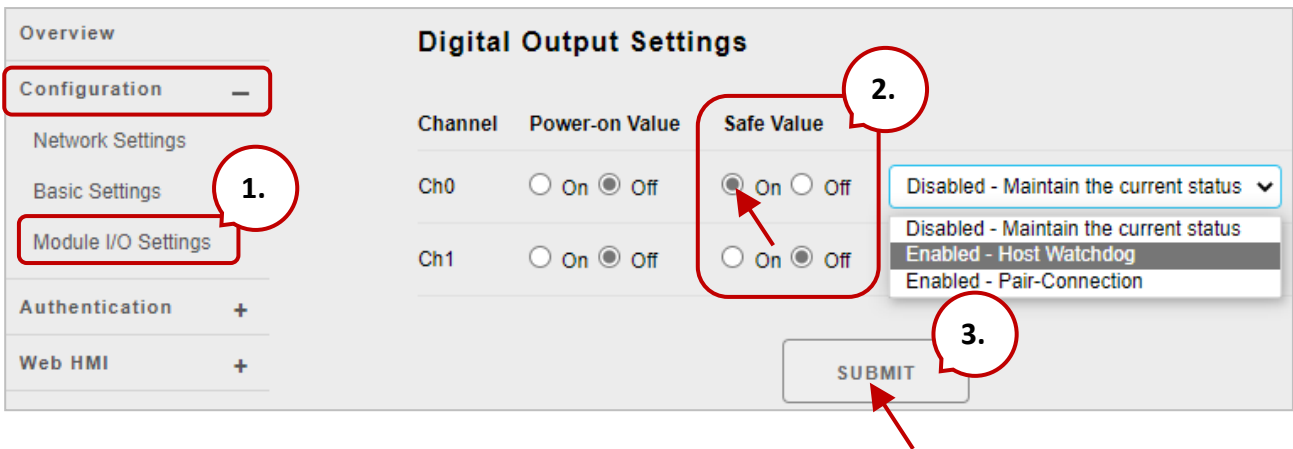

Step 1: Log into the ET-7x00/PET-7x00 web page, and then click the “**Module I/O Settings**” option in the “**Configuration**” section of the Main Menu.

Step 2: Enable the Safe Value by checking the “**ON**” radio button.

Step 3: Click the “**Submit**” button to complete the configuration of the Safe Value.

Setting the Safe Value for a Specific Analog Output Channel

The screenshot shows the 'Analog Output Settings' page. On the left is a navigation menu with 'Configuration' expanded, showing 'Module I/O Settings' selected. The main area has two sections. The top section shows 'Channel', 'Range', and 'Slew Rate' for Ch0 and Ch1. The bottom section shows 'Channel', 'Power-on Value', 'Safe Value', and a status dropdown for Ch0 and Ch1. Red callouts are placed over the 'Module I/O Settings' menu item, the 'Safe Value' input field for Ch0, and the 'SUBMIT' button at the bottom.

Channel	Range	Slew Rate
Ch0	35, -5 ~ 5 V	00, Immediate
Ch1	35, -5 ~ 5 V	00, Immediate

Channel	Power-on Value	Safe Value	Status
Ch0	0.0 -5 ~ 5 V	0.0 -5 ~ 5 V	Disabled - Maintain the current status
Ch1	0.0 -5 ~ 5 V	0.0 -5 ~ 5 V	Disabled - Maintain the current status

Step 1: Log into the ET-7x00/PET-7x00 web page, and then click the “**Module I/O Settings**” option in the “**Configuration**” section of the Main Menu.

Step 2: Set the Safe Value in the “**Safe Value**” text box.

Step 3: Click the “**Submit**” button to complete the configuration of the Safe Value and save the settings to the EEPROM.

A.4. AI High/Low Alarm

ET-7x00/PET-7x00 module equipped with the High/Low Alarm function. When the alarm function is activated, the value of the specified registers is 1. The status of the alarm is the result of comparing the analog input value with a given high alarm value or a low alarm value.

Address 00636 to 00667 can be used to enable/disable the AI High Alarm function.

Address 00668 to 00699 can be used to enable/disable the AI Low Alarm function.

AI High/Low Alarm Switch Table

Channel Number	AI High Alarm		AI Low Alarm	
	Register	Description	Register	Description
AI0	00636	0: Disable/1: Enable	00668	0: Disable/1: Enable
AI1	00637	0: Disable/1: Enable	00669	0: Disable/1: Enable
AI2	00638	0: Disable/1: Enable	00670	0: Disable/1: Enable
AI3	00639	0: Disable/1: Enable	00671	0: Disable/1: Enable
AI4	00640	0: Disable/1: Enable	00672	0: Disable/1: Enable
AI5	00641	0: Disable/1: Enable	00673	0: Disable/1: Enable
AI6	00642	0: Disable/1: Enable	00674	0: Disable/1: Enable
AI7	00643	0: Disable/1: Enable	00675	0: Disable/1: Enable
AI8	00644	0: Disable/1: Enable	00676	0: Disable/1: Enable
AI9	00645	0: Disable/1: Enable	00677	0: Disable/1: Enable

Address 40296 to 40327 records the High Alarm value. Address 40328 to 40359 record the Low Alarm value. By default, the High Alarm value is +32767 (0x7FFF) and the low alarm value is -32768 (0xFFFF).

AI High/Low Alarm Value Table

Channel Number	High Alarm Value of AI		Low Alarm Value of AI	
	Register	Description	Register	Description
AI0	40296	-32768 ~ 32767	40328	-32768 ~ 32767
AI1	40297	-32768 ~ 32767	40329	-32768 ~ 32767
AI2	40298	-32768 ~ 32767	40330	-32768 ~ 32767
AI4	40300	-32768 ~ 32767	40332	-32768 ~ 32767
AI5	40301	-32768 ~ 32767	40333	-32768 ~ 32767
AI6	40302	-32768 ~ 32767	40334	-32768 ~ 32767
AI7	40303	-32768 ~ 32767	40335	-32768 ~ 32767
AI8	40304	-32768 ~ 32767	40336	-32768 ~ 32767
AI9	40305	-32768 ~ 32767	40337	-32768 ~ 32767

The analog input High/Low Alarm contains two alarm types, Momentary Alarm and Latch Alarm. Address 00700 of the Modbus register can be used to set the High Alarm type of channel 0 and the total number of channels depends on the type of module. Address 00732 of the Modbus register can be used to set the Low Alarm type of channel 0.

AI High/Low Type Value Table

Channel Number	AI High Alarm Type		AI Low Alarm Type	
	Register	Description	Register	Description
AI0	00700	0: Momentary Mode 1: Latch Mode	00732	0: Momentary Mode 1: Latch Mode
AI1	00701	0: Momentary Mode 1: Latch Mode	00733	0: Momentary Mode 1: Latch Mode
AI2	00702	0: Momentary Mode 1: Latch Mode	00734	0: Momentary Mode 1: Latch Mode
AI3	00703	0: Momentary 1: Latched	00735	0: Momentary 1: Latched
AI4	00704	0: Momentary 1: Latched	00736	0: Momentary 1: Latched
AI5	00705	0: Momentary 1: Latched	00737	0: Momentary 1: Latched
AI6	00706	0: Momentary 1: Latched	00738	0: Momentary 1: Latched
AI7	00707	0: Momentary 1: Latched	00739	0: Momentary 1: Latched
AI8	00708	0: Momentary 1: Latched	00740	0: Momentary 1: Latched
AI9	00709	0: Momentary 1: Latched	00741	0: Momentary 1: Latched

The following are the descriptions for two alarm types.

Momentary Alarm

An alarm will be triggered when the analog input value exceeds alarm limits. When the AI value is back to normal, the alarm status will automatically be cleared.

For example:

If analog input value of channel 0 (Address: 30000) > High Alarm value (Address: 40296), the address 10224 is 1, else it is 0.

If the analog input Value of channel 0 (30000) < Low Alarm value (40328), the address 10256 is 1, else it is 0.

The address 10224 to 10255 is used to read the status of the high alarm. If a high alarm occurred, the Register value is 1. Under normal conditions, the value is 0. The address 10256 to 10287 is used to read the status of the low alarm. If a low alarm occurred, the Register value is 1. Under normal conditions, the value is 0.

Latch Alarm

An alarm will be triggered when the analog input value exceeds alarm limits. When the AI value is back to normal, the alarm status will keep until the clear command is sent to the specific address.

For example:

If the analog input value of channel 0 (30000) > High Alarm value (40296), the address 10224 is 1. If the analog input value of channel 0 (30000) < Low Alarm value (40328), the address 10256 is 1.

The address 10224 to 10255 is used to read the status of the high alarm. In normal conditions, the value of the register is 0. If a High alarm occurred, the Register value stays 1 until the status of the address(es) 00764 to 00795 is cleared. The address 10256 to 10287 is used to read the status of the Low alarm. In normal conditions, the value of the register is 0. If a low alarm occurred, the value of the register stays 1 until the status of the address(es) 00796 to 00827 is cleared.

Setting the High Alarm and Low Alarm for a Specific Analog Input Channel

The screenshot shows the 'Alarm Settings' page. On the left is a navigation menu with 'Configuration' expanded to show 'Module I/O Settings'. The main area is a table with columns for Channel, High Limit Value, and Mode. Channel Ch0 has 'Enable' selected and a High Limit Value of 10.0. A 'SUBMIT' button is at the bottom right.

Channel	High Limit Value	Mode
Ch0	10.0	Monemetary
Ch1	10.0	Latch
Ch2	10.0	Monemetary
Ch3	10.0	Monemetary
Ch4	10.0	Monemetary
Ch5	10.0	Monemetary

Step 1: Log into the ET-7x00/PET-7x00 web page, and then click the “**Module I/O Settings**” option in the “**Configuration**” section of the Main Menu.

Step 2: Set the High Alarm and Low Alarm information in the relevant field.

Step 3: Click the “**Submit**” button to complete the configuration of the High Alarm and the Low Alarm.

This is a close-up of the 'Low Limit Value' section of the 'Alarm Settings' page. It shows a table with columns for Channel, Low Limit Value, and Mode. Channel Ch0 has 'Enable' selected and a Low Limit Value of -10.0. A 'SUBMIT' button is at the bottom right.

Channel	Low Limit Value	Mode
Ch0	-10.0	Monemetary
Ch1	-10.0	Latch
Ch2	-10.0	Monemetary
Ch3	-10.0	Monemetary
Ch4	-10.0	Monemetary
Ch5	-10.0	Monemetary

A.5. AI High/Low Latch

The address 30236 to 30267 records the maximum value of analog inputs and stays the value until another maximum input enters. The address 30268 to 30299 records the minimum value of analog inputs and stays the value until another minimum input enters.

Monitoring the Alarm Status for a Specific Analog Input Channel

Click the “Web HMI” item from the “Web HMI” menu.

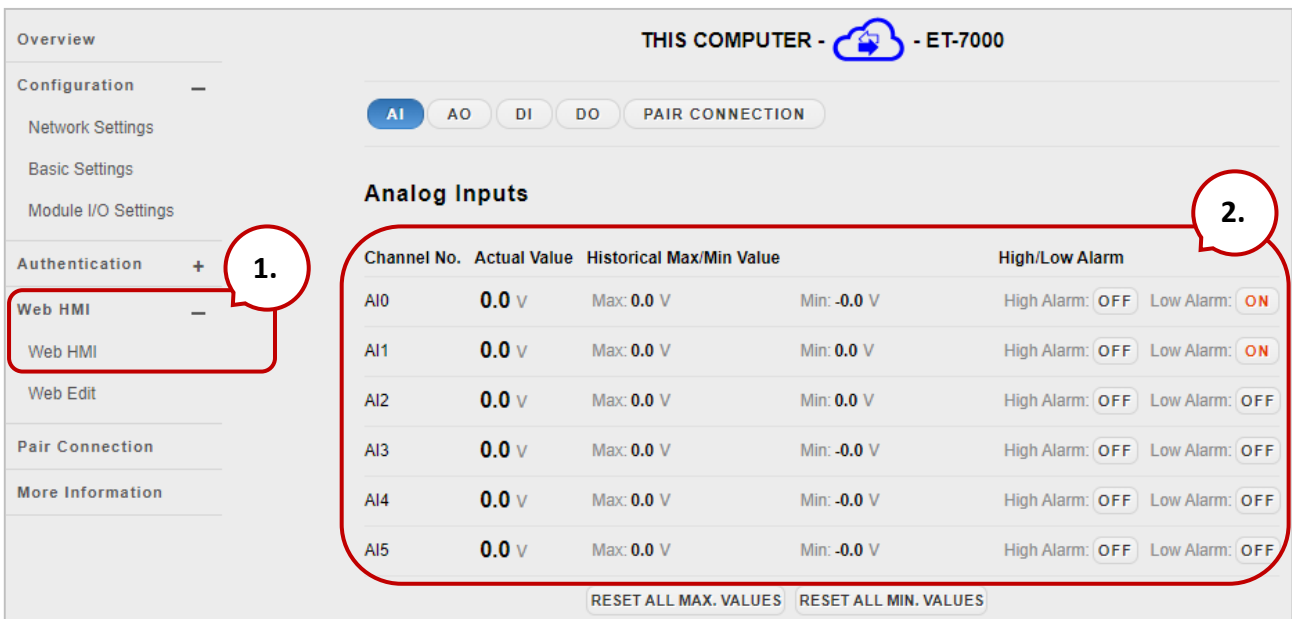

THIS COMPUTER -  - ET-7000

AI AO DI DO PAIR CONNECTION

Analog Inputs

Channel No.	Actual Value	Historical Max/Min Value	High/Low Alarm
AI0	0.0 V	Max: 0.0 V Min: -0.0 V	High Alarm: OFF Low Alarm: ON
AI1	0.0 V	Max: 0.0 V Min: 0.0 V	High Alarm: OFF Low Alarm: ON
AI2	0.0 V	Max: 0.0 V Min: 0.0 V	High Alarm: OFF Low Alarm: OFF
AI3	0.0 V	Max: 0.0 V Min: -0.0 V	High Alarm: OFF Low Alarm: OFF
AI4	0.0 V	Max: 0.0 V Min: -0.0 V	High Alarm: OFF Low Alarm: OFF
AI5	0.0 V	Max: 0.0 V Min: -0.0 V	High Alarm: OFF Low Alarm: OFF

RESET ALL MAX. VALUES RESET ALL MIN. VALUES

Step 1: Log into the ET-7x00/PET-7x00 web page, and then click the “Module I/O Settings” option in the “Configuration” section of the Main Menu.

Step 2: Monitor the alarm status by viewing the “Analog Inputs” group table.

Appendix B Analog Input Type and Data Format Table

Type Code	Input Range	Data Format	+F.S	-F.S
00	-15 ~ +15 mA	Engineering Unit	+15000	-15000
		2's comp HEX	7FFF	8000
01	-50 ~ +50 mA	Engineering Unit	+5000	-5000
		2's comp HEX	7FFF	8000
02	-100 ~ +100 mV	Engineering Unit	+10000	-10000
		2's comp HEX	7FFF	8000
03	-500 ~ +500 mV	Engineering Unit	+5000	-5000
		2's comp HEX	7FFF	8000
04	-1 ~ +1 V	Engineering Unit	+10000	-10000
		2's comp HEX	7FFF	8000
05	-2.5 ~ +2.5 V	Engineering Unit	+25000	-25000
		2's comp HEX	7FFF	8000
06	-20 ~ +20 mA	Engineering Unit	+20000	-20000
		2's comp HEX	7FFF	8000
07	+4 ~ +20 mA	Engineering Unit	+20000	+4000
		2's comp HEX	FFFF	0000
08	-10 ~ +10 V	Engineering Unit	+10000	-10000
		2's comp HEX	7FFF	8000
09	-5 ~ +5 V	Engineering Unit	+5000	-5000
		2's comp HEX	7FFF	8000
0A	-1 ~ +1 V	Engineering Unit	+10000	-10000
		2's comp HEX	7FFF	8000
0B	-500 ~ +500 mV	Engineering Unit	+5000	-5000
		2's comp HEX	7FFF	8000
0C	-150 ~ +150 mV	Engineering Unit	+15000	-15000
		2's comp HEX	7FFF	8000
0D	-20 ~ +20 mA	Engineering Unit	+20000	-20000
		2's comp HEX	7FFF	8000

Type Code	Input Range	Data Format	+F.S	-F.S
1A	0 ~ +20 mA	Engineering Unit	+20000	0
		2's comp HEX	FFFF	0000
0E	Type J Thermocouple -210 ~ 760°C	Engineering Unit	+7600	-2100
		2's comp HEX	7FFF	DCA2
0F	Type K Thermocouple -270 ~ 1372°C	Engineering Unit	+13720	-2700
		2's comp HEX	7FFF	E6D0
10	Type T Thermocouple -270 ~ 400°C	Engineering Unit	+4000	-2700
		2's comp HEX	7FFF	A99A
11	Type E Thermocouple -270 ~ 1000°C	Engineering Unit	10000	-2700
		2's comp HEX	7FFF	DD71
12	Type R Thermocouple 0 ~ 1768°C	Engineering Unit	+17680	0
		2's comp HEX	7FFF	0000
13	Type S Thermocouple 0 ~ 1768°C	Engineering Unit	+17680	0
		2's comp HEX	7FFF	0000
14	Type B Thermocouple 0 ~ 1820°C	Engineering Unit	+18200	0
		2's comp HEX	7FFF	0000
15	Type N Thermocouple -270 ~ 1300°C	Engineering Unit	+13000	-2700
		2's comp HEX	7FFF	E56B
16	Type C Thermocouple 0 ~ 2320°C	Engineering Unit	+23200	0
		2's comp HEX	7FFF	0000
17	Type L Thermocouple -200 ~ 800°C	Engineering Unit	+8000	-2000
		2's comp HEX	7FFF	E000
18	Type M Thermocouple -200 ~ 100°C	Engineering Unit	+10000	-20000
		2's comp HEX	4000	8000
19	Type L DIN43710 Thermocouple -200 ~ 900°C	Engineering Unit	9000	-2000
		2's comp HEX	FFFF	E38E
20	Platinum 100 $\alpha=0.00385$ -100 ~ 100°C	Engineering Unit	+10000	-10000
		2's comp HEX	7FFF	8000
21	Platinum 100 $\alpha=0.00385$ 0 ~ 100°C	Engineering Unit	+10000	0
		2's comp HEX	7FFF	0000

Type Code	Input Range	Data Format	+F.S	-F.S
22	Platinum 100 $\alpha=0.00385$ 0 ~ 200°C	Engineering Unit	+20000	0
		2's comp HEX	7FFF	0000
23	Platinum 100 $\alpha=0.00385$ 0 ~ 600°C	Engineering Unit	+6000	0
		2's comp HEX	7FFF	0000
24	Platinum 100 $\alpha=0.003916$ -100 ~ 100°C	Engineering Unit	+10000	-10000
		2's comp HEX	7FFF	8000
25	Platinum 100 $\alpha=0.003916$ 0 ~ 100°C	Engineering Unit	+10000	0
		2's comp HEX	7FFF	0000
26	Platinum 100 $\alpha=0.003916$ 0 ~ 200°C	Engineering Unit	+20000	0
		2's comp HEX	7FFF	0000
27	Platinum 100 $\alpha=0.003916$ 0 ~ 600°C	Engineering Unit	+6000	0
		2's comp HEX	7FFF	0000
28	Nickel 120 -80 ~ 100°C	Engineering Unit	+10000	-8000
		2's comp HEX	7FFF	999A
29	Nickel 120 0 ~ 100°C	Engineering Unit	+10000	0
		2's comp HEX	7FFF	0000
2A	Platinum 1000 $\alpha=0.00385$ -200 ~ 600°C	Engineering Unit	+6000	-2000
		2's comp HEX	7FFF	D556
2B	Cu 100 $\alpha=0.00421$ -20 ~ 150°C	Engineering Unit	+15000	-2000
		2's comp HEX	7FFF	EEEE
2C	Cu 100 $\alpha=0.00427$ 0 ~ 200°C	Engineering Unit	+20000	0
		2's comp HEX	7FFF	0000
2D	Cu 1000 $\alpha=0.00421$ -20 ~ 150°C	Engineering Unit	+15000	-2000
		2's comp HEX	7FFF	EEEE
2E	Platinum 1000 $\alpha=0.00385$ -200 ~ 200°C	Engineering Unit	+20000	-20000
		2's comp HEX	7FFF	8000
2F	Platinum 1000 $\alpha=0.003916$ -200 ~ 200°C	Engineering Unit	+20000	-20000
		2's comp HEX	7FFF	8000
60	PreCon Type III 10K@25°C, -30°F ~ 240°F	Engineering Unit	+24000	-3000
		2's comp HEX	7FFF	F000
61	Fenwell Type U 2K@25°C, -50°C ~ 150°C	Engineering Unit	+15000	-5000
		2's comp HEX	7FFF	D556

Type Code	Input Range	Data Format	+F.S	-F.S
62	Fenwell Type U 2K@25°C, 0°C ~ 150°C	Engineering Unit	+15000	0
		2's comp HEX	7FFF	0000
63	YSI L Mix 100@25°C, -80°C ~ 100°C	Engineering Unit	10000	-8000
		2's comp HEX	7FFF	999A
64	YSI L Mix 300@25°C, -80°C ~ 100°C	Engineering Unit	+10000	-8000
		2's comp HEX	7FFF	999A
65	YSI L Mix 1000@25°C, -70°C ~ 100°C	Engineering Unit	+10000	-7000
		2's comp HEX	7FFF	A667
66	YSI B Mix 2252@25°C, -50°C ~ 150°C	Engineering Unit	+15000	-5000
		2's comp HEX	7FFF	D556
67	YSI B Mix 3000@25°C, -40°C ~ 150°C	Engineering Unit	+15000	-4000
		2's comp HEX	7FFF	DDDE
68	YSI B Mix 5000@25°C, -40°C ~ 150°C	Engineering Unit	+15000	-4000
		2's comp HEX	7FFF	DDDE
69	YSI B Mix 6000@25°C, -30°C ~ 150°C	Engineering Unit	+15000	-3000
		2's comp HEX	7FFF	E667
6A	YSI B Mix 10000@25°C, -30°C ~ 150°C	Engineering Unit	+15000	-3000
		2's comp HEX	7FFF	E667
6B	YSI H Mix 10000@25°C, -30°C ~ 150°C	Engineering Unit	+15000	-3000
		2's comp HEX	7FFF	E667
6C	YSI H Mix 30000@25°C, -10°C ~ 200°C	Engineering Unit	+20000	-1000
		2's comp HEX	7FFF	F99A
70	User-defined, -50°C ~ 150°C	Engineering Unit	+15000	-5000
		2's comp HEX	7FFF	D556
71	User-defined, -50°C ~ 150°C	Engineering Unit	+15000	-5000
		2's comp HEX	7FFF	D556
72	User-defined, -50°C ~ 150°C	Engineering Unit	+15000	-5000
		2's comp HEX	7FFF	D556
73	User-defined, -50°C ~ 150°C	Engineering Unit	+15000	-5000
		2's comp HEX	7FFF	D556
74	User-defined, -50°C ~ 150°C	Engineering Unit	+15000	-5000
		2's comp HEX	7FFF	D556

Type Code	Input Range	Data Format	+F.S	-F.S
75	User-defined, -50°C ~ 150°C	Engineering Unit	+15000	-5000
		2's comp HEX	7FFF	D556
76	User-defined, -50°C ~ 150°C	Engineering Unit	+15000	-5000
		2's comp HEX	7FFF	D556
77	User-defined, -50°C ~ 150°C	Engineering Unit	+15000	-5000
		2's comp HEX	7FFF	D556
80	Platinum 100 $\alpha=0.00385$ -200 ~ 600°C	Engineering Unit	+6000	-2000
		2's comp HEX	7FFF	D556
81	Platinum 100 $\alpha=0.003916$ -200 ~ 600°C	Engineering Unit	+6000	-2000
		2's comp HEX	7FFF	D556
82	Cu 50 -50 ~ 150°C	Engineering Unit	+15000	-5000
		2's comp HEX	7FFF	D556
83	Nickel 100 -60 ~ 180°C	Engineering Unit	+18000	-6000
		2's comp HEX	7FFF	D556

Appendix C Analog Output Type and Data Format Table

Type Code	Output Range	Data Format	+F.S	-F.S
30	0 ~ +20 mA	Engineering Unit	+20000	0
		2's comp HEX	FFFF	0000
31	4 ~ +20 mA	Engineering Unit	+20000	4000
		2's comp HEX	FFFF	0000
32	0 ~ +10 V	Engineering Unit	+10000	0
		2's comp HEX	7FFF	0000
33	-10 ~ +10 V	Engineering Unit	+10000	-10000
		2's comp HEX	7FFF	8000
34	0 ~ +5 V	Engineering Unit	+5000	0
		2's comp HEX	7FFF	0000
35	-5 ~ +5 V	Engineering Unit	+5000	-5000
		2's comp HEX	7FFF	8000

Appendix D Modbus Data Scaling and Unit Conversion

All analog modules represent measured physical values through Modbus registers using scaled integer integers. Since raw Modbus data does not directly represent physical values, the Modbus master (e.g., PLC or SCADA) must perform conversion based on the specified scaling rules.

The analog module supports various physical quantities, such as voltage, current, and temperature, each with its own scaling method. Data representation in the Modbus registers can be configured in 2's Complement or Engineering Units. This chapter provides conversion examples based on specific input types and data format configurations.

Both input types and data formats are configurable via the module's web interface.

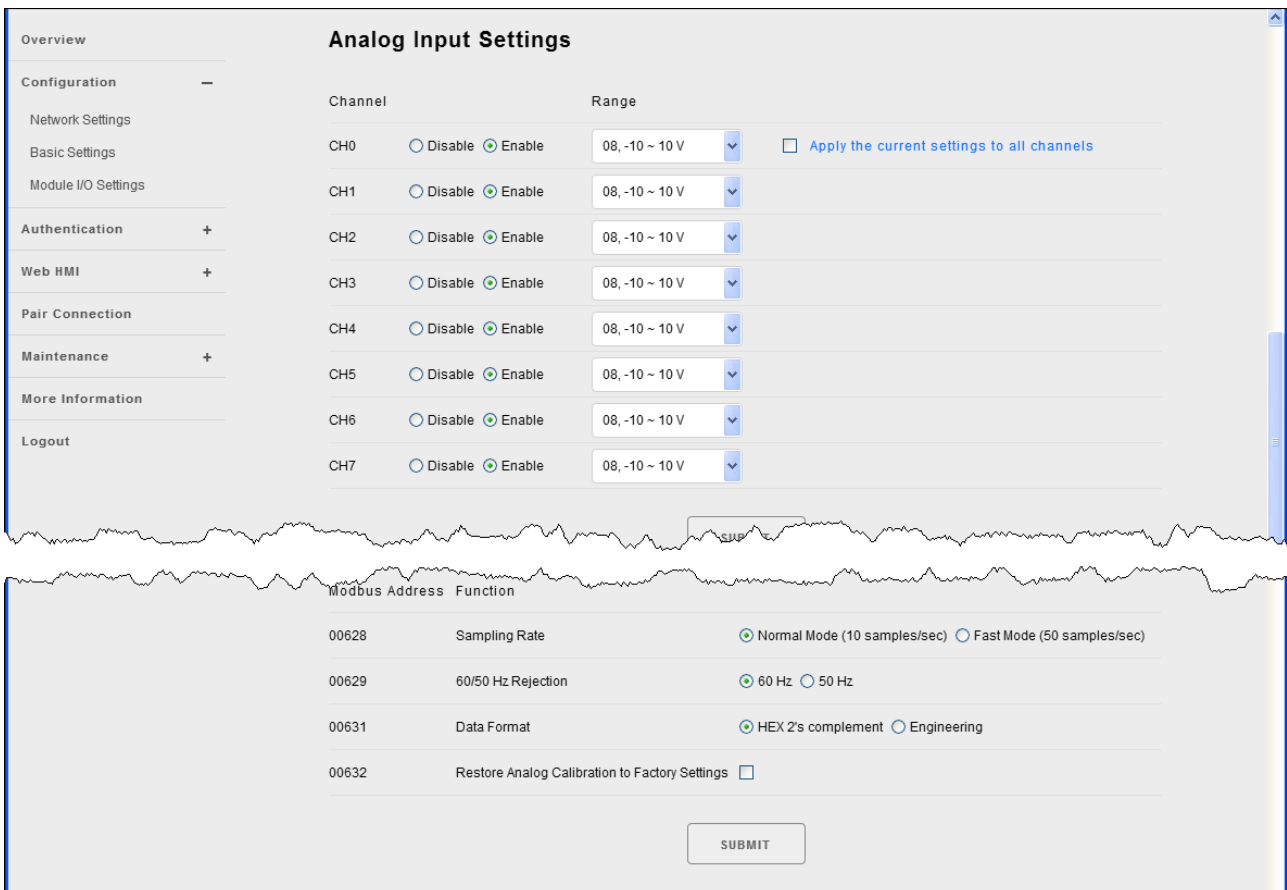

Modbus Data Representation

Modbus registers store 16-bit values that can be interpreted in several formats. Users must ensure they understand how to convert the raw register data into values that correspond to the actual physical quantities.

While a 16-bit word can represent unsigned integers (UINT16) from 0 to 65535, physical measurements often require a signed integer (INT16) format to accommodate negative values. In a signed format, the register range is typically -32768 to 32767.

Important:

Always verify whether the Modbus register is defined as UINT16 or INT16 before applying the conversion formula.

Engineering Unit

Each measured value—including voltage, current, and temperature—is multiplied by a predefined scaling factor (e.g., 10, 100, or 1000) before being stored. This scaling process allows the module to represent fractional precision within the constraints of 16-bit integer Modbus registers.

Conversion Formula

To obtain the actual physical measurement, apply the following formula:

$$\text{Actual Physical Value} = D_{\text{RAW}} \times F_{\text{SCALE}}$$

Where

- D_{RAW} : The 16-bit integer read from the Modbus register
- F_{SCALE} : The scaling factor corresponding to the specific input type.

Note:

Since different input types possess unique characteristics and measurement ranges, each has a specific Scale constant listed in the rightmost column of the table below.

Input Type	Modbus Data Representation	Modbus Value Range	Scale
-15mV to 15mV	16-bit integer	-15000 to 15000	0.001
-100mV to 100mV	16-bit integer	-10000 to 10000	0.01
-500mV to 500mV	16-bit integer	-5000 to 5000	0.1
-1V to 1V	16-bit integer	-10000 to 10000	0.0001

-5V to 5V	16-bit integer	-5000 to 5000	0.001
-10V to 10V	16-bit integer	-10000 to 10000	0.001
4mA to 20mA	16-bit unsigned integer	4000 to 20000	0.001
-270°C to 1372°C	16-bit integer	-2700 to 13720	0.01

Conversion Example (K-type thermocouple, -270 to 1372 °C)

If the measured temperature is 22.3 °C, the module multiplies it by a scaling factor of 100 and writes 2230 to the Modbus register.

When reading the register value from the module, the actual temperature can be obtained by multiplying the register value by the scaling factor:

$$22.3 (^{\circ}\text{C}) = 2230 * 0.01$$

Voltage Input Scaling (-10 to +10 V)

The analog module supports bipolar input ranges, including +/-10 V, +/- 20 mA. For analog input configured as bipolar analog input, the module represents measured values using a 16-bit signed integer (2's complement) format.

Input voltage range	-10 V to +10 V
Modbus data type	16-bit signed integer
Modbus value range	0x8000 to 0x7FFF (-32768 to 32767)
Lower limit mapping	0x8000 = -10 V
Upper limit mapping	0x7FFF = 10V

Conversion Formula

To convert the raw Modbus data to the actual measured voltage, apply the following formula:

$$\text{Voltage (V)} = D_{\text{RAW}} \times (10 / 32767)$$

Where

- D_{RAW} : The 16-bit integer read from the Modbus register
- $10/32767$: The voltage resolution constant. Each unit increment in the Modbus register corresponds to approximately 0.305 mV

Note:

For $D_{raw} = -32768$ (0x8000), the calculated result is slightly below -10 V using the formula above. In practice, the module clamps this value to -10 V.

Conversion Examples

Raw Modbus Value	Decimal	Actual Measured Voltage
0x8000	-32768	-10 (V) $\approx -32768 \times (10 / 32767)$
0x0000	0	0 (V) = $0 \times (10 / 32767)$
0x7FFF	32767	10 (V) = $32767 \times (10 / 32767)$

Current Input Scaling (4 to 20mA)

When configured for a 4-20 mA unipolar range, the module uses the full 16-bit unsigned integer range (0 to 65535) to represent the active signal span. The Modbus value 0 corresponds to the lower limit (4 mA), while 65535 corresponds to the upper limit (20 mA).

Input current range	4 to 20mA
Modbus data type	16-bit unsigned integer
Modbus value range	0x0000 to 0xFFFF (0 to 65535)
Lower limit mapping	0x0000 = 4mA
Upper limit mapping	0xFFFF = 20mA

Conversion Formula

$$\text{Current (mA)} = 4 + (D_{raw} \times 16 / 65535)$$

Where :

- D_{raw} : The 16-bit unsigned integer read from the Modbus register
- 16: The effective measurement span (20mA - 4mA)
- 65535: The denominator of the ratio, signifying the full scale of the Modbus register.
- 4: The signal offset, or live-zero, representing the minimum current.

Note:

The 4-20 mA input provides a live-zero indication. A value near 0 mA may indicate a wiring fault or sensor failure.

Conversion Examples

Raw Modbus Value	Decimal	Actual Measured Current
0x0000	0	4 (mA) = 4 + (0 × 16 / 65535)
0x8000	32768	12 (mA) ≈ 4 + (32768 × 16 / 65535)
0xFFFF	65535	4 (mA) = 4 + (65535 × 16 / 65535)

Temperature Input Scaling (K-type thermocouple, -270 to 1372 °C)

Temperature range	-270°C to +1372°C
Modbus data type	16-bit signed integer
Modbus value range	0xE6D0 to 0x7FFF (-6448 to 32767)
Lower limit mapping	0xE6D0 = -270°C
Upper limit mapping	0x7FFF = 1372°C

Conversion Formula

To convert the Modbus value to the actual temperature, use the following formula:

$$\text{Temperature (°C)} = D_{RAW} \times (1372 / 32767)$$

Where

- D_{RAW} : The 16-bit signed integer read from the Modbus register
- 1372: The maximum positive temperature value defined for the input type
- 32767: The maximum positive value of a 16-bit signed integer
- (1372 / 32767) represents the resolution. Each unit increment in the Modbus register corresponds to a change of approximately 0.04187°C

Note:

The Modbus register must be interpreted as a 16-bit signed integer. Treating it as unsigned will result in incorrect temperature readings for negative values.

Conversion Examples

Raw Modbus Value	Decimal	Actual Measured Temperature
0xE6D0	-6448	-270 (°C) ≈ -6448 × (1372 / 32767)
0x0000	0	0 (°C) ≈ 0 × (1372 / 32767)
0x7FFF	32767	1372 (°C) = 32767 × (1372 / 32767)

Appendix E Network Address Translation

For a computer to communicate with ET-7x00/PET-7x00 modules on the Internet, ET-7x00/PET-7x00 modules must have a public IP address. It works like your street address - as a way to find out exactly where you are and deliver information to you.

Network Address Translation (NAT) allows a single device, such as a router, to act as an agent between the Internet (or "**public network**") and a local (or "**private**") network. This means that only a single, unique IP address is required to represent an entire group of computers.

A type of NAT in which a private IP address is mapped to a public IP address, where the public address is always the same IP address (i.e., it has a static address). This allows an internal host, such as an ET-7x00/PET-7x00 module, to have an unregistered (private) IP address and still be reachable over the Internet.

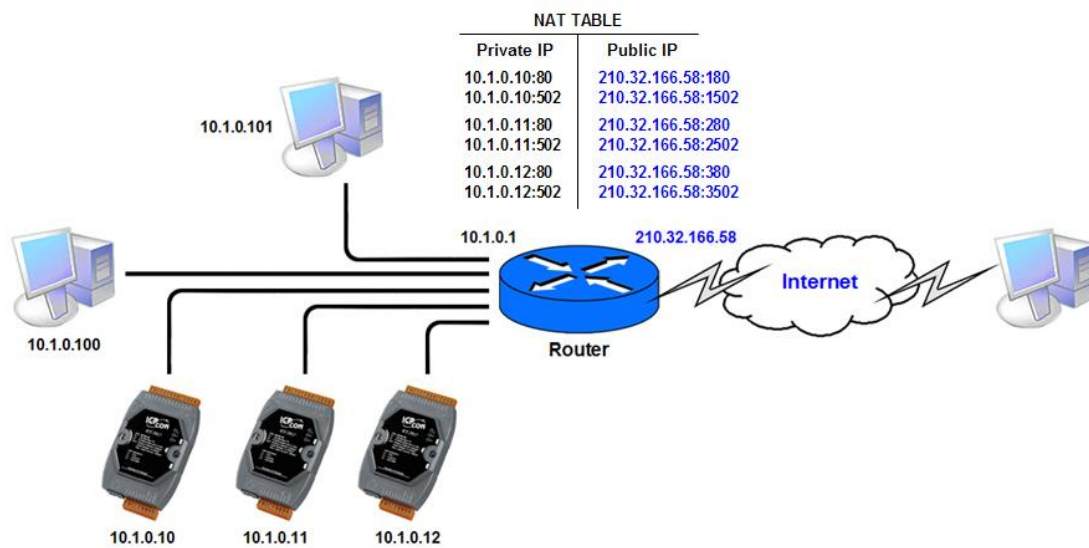

Step 1: Configure the Ethernet settings of the ET-7x00/PET-7x00 module.

The Gateway must be set to the IP address of the router (i.e., 10.1.0.1)

Overview

Ethernet Configuration

Configure:

IP address: Subnet mask: Gateway:

Step 2: Connect to the Web Server of the ET-7x00/PET-7x00 module with the public IP address on the Internet.

To access the web page, the port number must be included in the access URL as shown below:

<http://210.32.166.58:180>

ICP DAS
<http://www.icpdas.com>

ET-7026 / PET-7026

An Ethernet module that is equipped with 2 digital outputs, 2 digital inputs, 2 analog outputs and 6 analog inputs.

Module Information:

MAC Address:	00:0D:E0:65:D7:90
Firmware Version:	3.0.1 (Apr. 13, 2021)
I/O Version:	1.08
Ethernet Version:	1.29 (Feb. 25, 2019)
Web Server Version:	2.1.01 (Feb. 26, 2016)
OS Version:	2.4.0 (Nov. 24, 2016)

Appendix F Troubleshooting

Several common problems are easy to diagnose and fix if you know the cause.

Symptom/Problem	
Possible cause	Solution
<ul style="list-style-type: none"> ● The Run LED doesn't light 	
Internal power has failed	Return the module for repair.

<ul style="list-style-type: none"> ● The Run LED indicator is ON (light), but not flashing. 	
The module has possibly crashed.	Reboot the module

<ul style="list-style-type: none"> ● Cannot communicate via the Ethernet port, but the ET-7x00/PET-7x00 is still operating. 	
The IP/Mask/Gateway address isn't within the IP address range of the LAN.	Change the IP/Mask/Gateway address to match the LAN, or ask the MIS administrator for assistance.
The IP address has restricted by the IP filter settings	Check the IP filter settings using the Web configuration.
There are more than 30 TCP/IP connections.	Reboot the module.

<ul style="list-style-type: none"> ● Able to explore the web page through Port 80 using a web browser, but the Web HMI and Modbus/TCP program cannot access the module through Port 502. 	
Port 502 has been restricted by the firewall.	Consult your MIS administrator for assistance.

<ul style="list-style-type: none"> ● The Web HMI and Modbus/TCP program can access the module through Port 502, but the Web browser cannot explore the web page through Port 80 using a web browser. 	
Port 80 has been restricted by the firewall.	Consult your MIS administrator for assistance.
The Web server TCP Port has been changed from Port 80, refer to the Basic Settings page.	Change the TCP Port to 80 or reconnect the ET-7x00/PET-7x00 using the specific TCP Port.